



FLEX I/O 240V AC Digital Input and Output Modules

Catalog numbers 1794-IM16, 1794-OM16

Table of Contents

Topic	Page
Important User Information	2
Environment and Enclosure	3
Prevent Electrostatic Discharge	3
North American Hazardous Location Approval	4
Install Your Digital Module	6
Configure Your AC Module	10
Specifications	12

Important User Information

Solid-state equipment has operational characteristics differing from those of electromechanical equipment. Safety Guidelines for the Application, Installation, and Maintenance of Solid-State Controls (Publication [SGI-1.1](#) available from your local Rockwell Automation Sales Office or online at <http://www.rockwellautomation.com/literature/>) describes some important differences between solid-state equipment and hard-wired electromechanical devices. Because of this difference, and also because of the wide variety of uses for solid-state equipment, all persons responsible for applying this equipment must satisfy themselves that each intended application of this equipment is acceptable.





In no event will Rockwell Automation, Inc. be responsible or liable for indirect or consequential damages resulting from the use or application of this equipment.

The examples and diagrams in this manual are included solely for illustrative purposes. Because of the many variables and requirements associated with any particular installation, Rockwell Automation, Inc. cannot assume responsibility or liability for actual use based on the examples and diagrams.

No patent liability is assumed by Rockwell Automation, Inc. with respect to use of information, circuits, equipment, or software described in this manual.

Reproduction of the contents of this manual, in whole or in part, without written permission of Rockwell Automation, Inc., is prohibited.

Throughout this manual, when necessary, we use notes to make you aware of safety considerations.

	WARNING: Identifies information about practices or circumstances that can cause an explosion in a hazardous environment, which may lead to personal injury or death, property damage, or economic loss.
	ATTENTION: Identifies information about practices or circumstances that can lead to personal injury or death, property damage, or economic loss. Attentions help you identify a hazard, avoid a hazard, and recognize the consequences.
	SHOCK HAZARD: Labels may be on or inside the equipment (for example, drive or motor) to alert people that dangerous voltage may be present.
	BURN HAZARD: Labels may be on or inside the equipment (for example, drive or motor) to alert people that surfaces may reach dangerous temperatures.
IMPORTANT	Identifies information that is critical for successful application and understanding of the product.

Environment and Enclosure



ATTENTION: This equipment is intended for use in a Pollution Degree 2 industrial environment, in overvoltage Category II applications (as defined in EN/IEC 60664-1), at altitudes up to 2000 m (6562 ft) without derating.

This equipment is not intended for use in residential environments and may not provide adequate protection to radio communication services in such environments.

This equipment is supplied as open-type equipment for indoor use. It must be mounted within an enclosure that is suitably designed for those specific environmental conditions that will be present and appropriately designed to prevent personal injury resulting from accessibility to live parts. The enclosure must have suitable flame-retardant properties to prevent or minimize the spread of flame, complying with a flame spread rating of 5VA or be approved for the application if nonmetallic. The interior of the enclosure must be accessible only by the use of a tool. Subsequent sections of this publication may contain more information regarding specific enclosure type ratings that are required to comply with certain product safety certifications.

In addition to this publication, see the following:

- Industrial Automation Wiring and Grounding Guidelines, publication [1770-4.1](#), for more installation requirements.
- NEMA Standard 250 and EN/IEC 60529, as applicable, for explanations of the degrees of protection provided by enclosures.

Prevent Electrostatic Discharge





ATTENTION: This equipment is sensitive to electrostatic discharge, which can cause internal damage and affect normal operation. Follow these guidelines when you handle this equipment:

- Touch a grounded object to discharge potential static.
 - Wear an approved grounding wriststrap.
 - Do not touch connectors or pins on component boards.
 - Do not touch circuit components inside the equipment.
 - Use a static-safe workstation, if available.
 - Store the equipment in appropriate static-safe packaging when not in use.
-

4 FLEX I/O 240V AC Digital Input and Output Modules

North American Hazardous Location Approval

The following modules are North American Hazardous Location approved: 1794-IM16, 1794-OM16.

The following information applies when operating this equipment in hazardous locations:	Informations sur l'utilisation de cet équipement en environnements dangereux:
<p>Products marked "CL I, DIV 2, GP A, B, C, D" are suitable for use in Class I Division 2 Groups A, B, C, D, Hazardous Locations and nonhazardous locations only. Each product is supplied with markings on the rating nameplate indicating the hazardous location temperature code. When combining products within a system, the most adverse temperature code (lowest "T" number) may be used to help determine the overall temperature code of the system. Combinations of equipment in your system are subject to investigation by the local Authority Having Jurisdiction at the time of installation.</p>	<p>Les produits marqués "CL I, DIV 2, GP A, B, C, D" ne conviennent qu'à une utilisation en environnements de Classe I Division 2 Groupes A, B, C, D dangereux et non dangereux. Chaque produit est livré avec des marquages sur sa plaque d'identification qui indiquent le code de température pour les environnements dangereux. Lorsque plusieurs produits sont combinés dans un système, le code de température le plus défavorable (code de température le plus faible) peut être utilisé pour déterminer le code de température global du système. Les combinaisons d'équipements dans le système sont sujettes à inspection par les autorités locales qualifiées au moment de l'installation.</p>
 <p>EXPLOSION HAZARD</p> <ul style="list-style-type: none">• Do not disconnect equipment unless power has been removed or the area is known to be nonhazardous.• Do not disconnect connections to this equipment unless power has been removed or the area is known to be nonhazardous. Secure any external connections that mate to this equipment by using screws, sliding latches, threaded connectors, or other means provided with this product.• Substitution of components may impair suitability for Class I, Division 2.	 <p>RISQUE D'EXPLOSION</p> <ul style="list-style-type: none">• Couper le courant ou s'assurer que l'environnement est classé non dangereux avant de débrancher l'équipement.• Couper le courant ou s'assurer que l'environnement est classé non dangereux avant de débrancher les connecteurs. Fixer tous les connecteurs externes reliés à cet équipement à l'aide de vis, loquets coulissants, connecteurs filetés ou autres moyens fournis avec ce produit.• La substitution de composants peut rendre cet équipement inadapté à une utilisation en environnement de Classe I, Division 2.



ATTENTION: If this equipment is used in a manner not specified by the manufacturer, the protection provided by the equipment may be impaired.

ATTENTION: Read this document and the documents listed in the Additional Resources section about installation, configuration, and operation of this equipment before you install, configure, operate, or maintain this product. Users are required to familiarize themselves with installation and wiring instructions in addition to requirements of all applicable codes, laws, and standards.

ATTENTION: Installation, adjustments, putting into service, use, assembly, disassembly, and maintenance are required to be carried out by suitably trained personnel in accordance with applicable code of practice.

ATTENTION: In case of malfunction or damage, no attempts at repair should be made. The module should be returned to the manufacturer for repair. Do not dismantle the module.

ATTENTION: This equipment is certified for use only within the surrounding air temperature range of 0...55 °C (32...131 °F). The equipment must not be used outside of this range.

ATTENTION: Use only a soft dry anti-static cloth to wipe down equipment. Do not use any cleaning agents.



ATTENTION: This product is grounded through the DIN rail to chassis ground. Use zinc plated chromate-passivated steel DIN rail to assure proper grounding. The use of other DIN rail materials (for example, aluminum or plastic) that can corrode, oxidize, or are poor conductors, can result in improper or intermittent grounding. Secure DIN rail to mounting surface approximately every 200 mm (7.8 in.) and use end-anchors appropriately. Be sure to ground the DIN rail properly. Refer to Industrial Automation Wiring and Grounding Guidelines, Rockwell Automation publication [1770-4.1](#), for more information.



WARNING: When you insert or remove the module while backplane power is on, an electric arc can occur. This could cause an explosion in hazardous location installations.

Be sure that power is removed or the area is nonhazardous before proceeding. Repeated electric arcing causes excessive wear to contacts on both the module and its mating connector. Worn contacts may create electrical resistance that can affect module operation.

6 FLEX I/O 240V AC Digital Input and Output Modules



WARNING: If you insert or remove the module while backplane power is on, an electrical arc can occur. This could cause an explosion in hazardous location installations.

Be sure that power is removed or the area is nonhazardous before proceeding.



WARNING: Do not connect control circuit directly to line voltage. Line voltage must be supplied by a suitable, approved isolating transformer or power supply having short circuit capacity not exceeding 100 VA maximum or equivalent.



WARNING: If you connect or disconnect wiring while the field-side power is on, an electrical arc can occur. This could cause an explosion in hazardous location installations. Be sure that power is removed or the area is nonhazardous before proceeding.

Install Your Digital Module

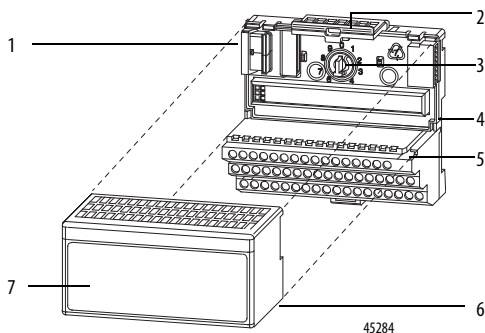

	Description		Description
1	FlexBus connectors	5	Groove
2	Latching mechanism	6	Alignment bar
3	Keyswitch	7	Module
4	Terminal base		

The module mounts on a 1794 terminal base.



ATTENTION: Do not remove or replace a Terminal Base unit when power is applied. Interruption of the backplane can result in unintentional operation or machine motion.



ATTENTION: During mounting of all devices, be sure that all debris (metal chips, wire strands, etc.) is kept from falling into the module. Debris that falls into the module could cause damage on power up.

1. Rotate the keyswitch (3) on the terminal base (4) clockwise to position 8 as required for this type of module.
2. Make sure the FlexBus connector (1) is pushed all the way to the left to connect with the neighboring terminal base/adaptor. **You cannot install the module unless the connector is fully extended.**
3. Make sure the pins on the bottom of the module are straight so they will align properly with the connector in the terminal base.
4. Position the module (7) with its alignment bar (6) aligned with the groove (5) on the terminal base.
5. Press firmly and evenly to seat the module in the terminal base unit. The module is seated when the latching mechanism (2) is locked into the module.

Connect Wiring for your 1794-IM16 Module

(using a 1794-TBN Terminal Base)

1. Connect individual input wiring to terminals 0...15 on the 16-33 row (B), and on the 34-51 row (C) as indicated in the Wiring Connections for 1794-IM16 and 1794-OM16 table. Auxiliary terminal blocks are required to distribute 240V AC power (L1) to each device.
2. Connect 240V AC power (L1) to terminal 34 on the 34-51 row (C).
3. Connect 240V AC common (L2) to terminal 16 on the 16-33 row (B).
4. If daisy chaining power to the next terminal base, connect a jumper from terminal 51 (240V AC L1) on this base unit to terminal 34 on the next base unit.
5. If continuing AC common to the next base unit, connect a jumper from terminal 33 (240V common L2) on this base unit to terminal 16 on the next base unit.

Connect Wiring for your 1794-OM16 Module

(using a 1794-TBN or TBNF Terminal Base)

1. Connect individual output wiring to terminals 0...15 on the 16-33 row (B), and the 34-51 row (C) as indicated in the Wiring Connections for 1794-IM16 and 1794-OM16 table.
2. Auxiliary terminal blocks are required to connect the associated L2 common for each channel. Connect the L2 side of the load together and then connect to L2 on the power supply.
3. Connect 240V AC power L1 to terminal 34 on the 34-51 row (C).
4. Connect 240V AC common L2 to terminal 16 on the 16-33 row (B).
5. If daisy chaining power to the next terminal base, connect a jumper from terminal 51 (240V AC L1) on this base unit to terminal 34 on the next base unit.
6. If continuing 240V AC common (L2) to the next base unit, connect a jumper from terminal 33 (240V AC common L2) on this base unit to terminal 16 on the next base unit.

Note: Total current draw through terminal base connection is limited to 10 A. Separate power connections to each terminal base may be necessary.

Wiring Connections for 1794-IM16 and 1794-OM16

1794-IM16		1794-OM16	
Input	1794-TBN	Output	1794-TBN, 1794-TBNF
	Input Terminal ⁽¹⁾		Output Terminal ⁽²⁾
Input 0	B-0	Output 0	B-0
Input 1	C-1	Output 1	C-1
Input 2	B-2	Output 2	B-2
Input 3	C-3	Output 3	C-3
Input 4	B-4	Output 4	B-4
Input 5	C-5	Output 5	C-5
Input 6	B-6	Output 6	B-6
Input 7	C-7	Output 7	C-7
Input 8	B-8	Output 8	B-8

Wiring Connections for 1794-IM16 and 1794-OM16

1794-IM16		1794-OM16	
Input	1794-TBN	Output	1794-TBN, 1794-TBNF
	Input Terminal ⁽¹⁾		Output Terminal ⁽²⁾
Input 9	C-9	Output 9	C-9
Input 10	B-10	Output 10	B-10
Input 11	C-11	Output 11	C-11
Input 12	B-12	Output 12	B-12
Input 13	C-13	Output 13	C-13
Input 14	B-14	Output 14	B-14
Input 15	C-15	Output 15	C-15
240V AC L1	Power terminals C-34 and C-51 are internally connected together. Connect 240V AC L1 to C-34		
240V AC L2	Common terminals B-16 and B-33 are internally connected together. Connect 240V AC common L2 to terminal B-16		

⁽¹⁾ Auxiliary terminal blocks are required to distribute 240V AC power L1 to each device.

⁽²⁾ Auxiliary terminal blocks are required to connect the associated L2 common for each channel.

1794-TBN Terminal Base Wiring for 1794-IM16 and 1794-OM16

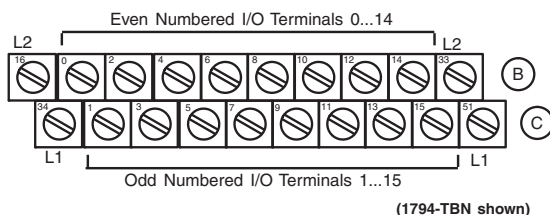

L1 = 240V AC - Connect to terminal C-34

L2 = 240V AC common - Connect to terminal B-16

Use B-33 and C-51 for daisy chaining to the next terminal base unit

Configure Your AC Module

Image Table Memory Map for the 1794-IM16 Module

Dec	15	14	13	12	11	10	9	8	7	6	5	4	3	2	1	0
Oct	17	16	15	14	13	12	11	10	7	6	5	4	3	2	1	0
Read	Input Data															
Read	Bit 15 Counter															
Write	R	EF	EC	Reserved							Filter Time 12...15			Filter Time 0...11		
Where	I = Input status R = Reserved EF = Enable Filter 0 = Enabled EC = Enable Counter 0 = Enabled															

Image Table Memory Map for the 1794-OM16 Module

Dec	15	14	13	12	11	10	9	8	7	6	5	4	3	2	1	0
Oct	17	16	15	14	13	12	11	10	7	6	5	4	3	2	1	0
Read	Not used – set to 0															
Write	O15	O14	O13	O12	O11	O10	O9	O8	O7	O6	O5	O4	O3	O2	O1	O0
Where	O = Output															

Set the Input Filter Time for the 1794-IM16 Module

You can increase the input filter time (FT) for channels 00...15 by setting the corresponding bits in the output image table (complementary word) for the module.

	15	14	13	12	11	10	9	8	7	6	5	4	3	2	1	0	Dec.
0:010																	
											FT = 12...15			FT = 0...11			

For example, setting bits 00, 01, and 02 as shown below sets the off-to-on filter time for inputs 00...11 to 12 ms. For other settings, refer to the Input Filter Time table.

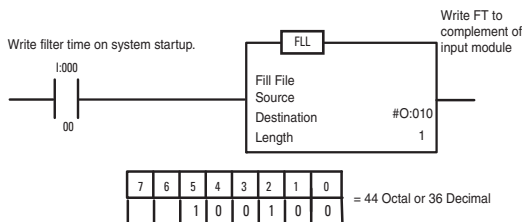

To increase the filter time, set the bits according to the table below.

Input Filter Times

Bits			Description	Selected Filter Time	Maximum Filter Time (ms)	
02	01	00			Off to On	On to Off
02	01	00	Filter Time for inputs 00...11			
05	04	03	Filter Time for inputs 12...15			
0	0	0	Filter Time 0 (Default)	256 μ s	7.5	26.5
0	0	1	Filter Time 1	512 μ s	8	27
0	1	0	Filter Time 2	1 ms	9	28
0	1	1	Filter Time 3	2 ms	10	29
1	0	1	Filter Time 4	4 ms	12	31
1	0	1	Filter Time 5	8 ms	16	35
1	1	0	Filter Time 6	16 ms	24.5	44
1	1	1	Filter Time 7	32 ms	42	60.5

Specifications

Specifications – FLEX I/O 240V AC Input Module 1794-IM16

Attribute	Value
Number of inputs	16, nonisolated
Recommended terminal base unit	1794-TBN, 1794-TBNK
On-state voltage, min	159V AC
On-state voltage, nom	240V AC
On-state voltage, max	264V AC
On-state current, min	5.30 mA
On-state current, max	13.29 mA
Off-state voltage, max	40V AC
Off-state current, max	2.6 mA
Nominal input impedance	22.2 k Ω
Nominal input current	11 mA @ 240V AC
Isolation voltage	250V (continuous), Basic Insulation Type, field side to backplane Type tested at 1530V AC for 60 s No isolation between individual channels
Input filter time ⁽¹⁾ Off to On On to Off	Refer to Input Filter Times table
FlexBus current	32 mA @ 5V DC
Power dissipation, max	6 W @ 264V AC
Thermal dissipation, max	20.47 BTU/hr @ 264V AC

⁽¹⁾ Input off-to-on filter time is the time from a valid input signal to recognition by the module.
Input on-to-off filter time is time from the input signal dropping below the valid level to recognition by the module.

Specifications – FLEX I/O 240V AC Output Module 1794-OM16

Attribute	Value
Number of outputs	16, nonisolated
Recommended terminal base unit	1794-TBN, 1794-TBNF, 1794-TBNK, 1794-TBNFK
Output voltage, min	159V AC
Output voltage, nom	240V AC
Output voltage, max	264V AC
Output current rating	4.0 A max per module ⁽²⁾ (16 outputs @ 250 mA)
On-state current	500 mA @ 55 °C (50 mA min)
Surge current	7 A for 40 ms each, repeatable every 8 seconds
Off-state leakage, max	2.5 mA
Isolation voltage	250V (continuous), Basic Insulation Type, field side to backplane Type tested at 1530V AC for 60 s No isolation between individual channels
Output signal delay ⁽¹⁾ Off to On On to Off	1/2 cycle max 1/2 cycle max
FlexBus current	116 mA @ 5V DC
Power dissipation, max	6 W @ 264V AC
Thermal dissipation, max	20.47 BTU/hr @ 264V A

⁽¹⁾ Delay time is the time from the receipt of an output on or off command to the output actually turning on or off.

⁽²⁾ If using 0.5 A outputs, alternate wiring so that no two 0.5 A outputs are next to each other.



ATTENTION: 1794-OM16 module outputs are not fused. Fused outputs are recommended.

If not using a 1794-TBNF terminal base and fusing is required, external fusing must be provided.

14 FLEX I/O 240V AC Digital Input and Output Modules

General Specifications

Attribute	Value
Terminal base screw torque	Determined by installed terminal base
Dimensions, approx. (H x W x D)	94 x 94 x 91 mm (3.7 x 3.7 x 3.6 in.)
Weight, approx.	141 g (4.97 oz.) – 1794-IM16 108 g (3.81 oz.) – 1794-OM16
Indicators (field side)	16 yellow status indicators
External AC power supply voltage, nom	240V AC
External AC power voltage range	159...264V AC
Terminal base load current, max	10 A – for 1794-OM16 only
Pilot duty rating	C300 – for 1794-OM16 only
North American temp code	T4
Keyswitch position	8
Enclosure type rating	None (open-style)
Wire size	Determined by installed terminal base
Wiring category ^{(1) (2)}	2 - on signal ports

⁽¹⁾ Use this Conductor Category information for planning conductor routing. Refer to Industrial Automation Wiring and Grounding Guidelines, publication [1770-4.1](#).

⁽²⁾ Use this Conductor Category information for planning conductor routing as described in the appropriate System Level Installation Manual.



At the end of its life, this equipment should be collected separately from any unsorted municipal waste.

Environmental Specifications

Attribute	Value
Temperature, operating	IEC 60068-2-1 (Test Ad, Operating Cold), IEC 60068-2-2 (Test Bd, Operating Dry Heat), IEC 60068-2-14 (Test Nb, Operating Thermal Shock): 0...55 °C (32...131 °F)
Temperature, surrounding air, max.	55 °C (131 °F)
Temperature, nonoperating	IEC 60068-2-1 (Test Ab, Unpackaged Nonoperating Cold), IEC 60068-2-2 (Test Bb, Unpackaged Nonoperating Dry Heat), IEC 60068-2-14 (Test Na, Unpackaged Nonoperating Thermal Shock): -40...85 °C (-40...185 °F)
Relative humidity	IEC 60068-2-30 (Test Db, Unpackaged Damp Heat): 5...95% non-condensing
Vibration	IEC60068-2-6 (Test Fc, Operating): 5 g @ 10...500 Hz
Shock, operating	IEC60068-2-27 (Test Ea, Unpackaged shock): 30 g
Shock, nonoperating	IEC60068-2-27 (Test Ea, Unpackaged shock): 50 g
Emissions	IEC 61000-6-4
ESD immunity	IEC 61000-4-2: 6 kV contact discharges 8 kV air discharges
Radiated RF immunity	IEC 61000-4-3: 10V/m with 1 kHz sine-wave 80% AM from 80...2000 MHz 10V/m with 200 Hz 50% Pulse 100% AM @ 900 MHz 10V/m with 200 Hz 50% Pulse 100% AM @ 1890 MHz 1V/m with 1 kHz sine-wave 80% AM from 2000...2700 MHz
EFT/B immunity	IEC 61000-4-4: ±2 kV @ 5 kHz on power ports ±2 kV @ 5 kHz on signal ports
Surge transient immunity	IEC 61000-4-5: ±1 kV line-line(DM) and ±2 kV line-earth(CM) on signal ports
Conducted RF immunity	IEC 61000-4-6: 10V rms with 1 kHz sine-wave 80% AM from 150 kHz...80 MHz

Certifications

Certifications (when product is marked)⁽¹⁾	Value
c-UL-us	UL Listed Industrial Control Equipment, certified for US and Canada. See UL File E322657. UL Listed for Class I, Division 2, Group A, B, C, D Hazardous Locations, certified for US and Canada. See UL File E334470.
CE	European Union 2014/30/EU EMC Directive, compliant with: EN 61326-1; Meas./Control/Lab., Industrial Requirements EN 61000-6-2; Industrial Immunity EN 61000-6-4; Industrial Emissions EN 61131-2; Programmable Controllers (Clause 8, Zone A & B) European Union 2014/35/EU LVD, compliant with: EN 61131-2; Programmable Controllers (Clause 11) European Union 2011/65/EU RoHS, compliant with: EN 50581; Technical Documentation
RCM	Australian Radiocommunications Act, compliant with: EN 61000-6-4; Industrial Emissions
KC	Korean Registration of Broadcasting and Communications Equipment, compliant with: Article 58-2 of Radio Waves Act, Clause 3
EAC	Russian Customs Union TR CU 020/2011 EMC Technical Regulation Russian Customs Union TR CU 004/2011 LV Technical Regulation

⁽¹⁾ See the Product Certification link at <http://www.rockwellautomation.com/global/certification/overview.page> for Declarations of Conformity, Certificates, and other certification details.

Notes:

Rockwell Automation Support

Rockwell Automation provides technical information on the Web to assist you in using its products. At <http://www.rockwellautomation.com/support/>, you can find technical manuals, a knowledge base of FAQs, technical and application notes, sample code and links to software service packs, and a MySupport feature that you can customize to make the best use of these tools.

For an additional level of technical phone support for installation, configuration and troubleshooting, we offer TechConnect support programs. For more information, contact your local distributor or Rockwell Automation representative, or visit <http://www.rockwellautomation.com/support/>.

Installation Assistance

If you experience a problem within the first 24 hours of installation, please review the information that's contained in this manual. You can also contact a special Customer Support number for initial help in getting your product up and running.

United States or Canada	1.440.646.3434
Outside United States or Canada	Use the Worldwide Locator at http://www.rockwellautomation.com/support/americas/phone_en.html , or contact your local Rockwell Automation representative.

New Product Satisfaction Return

Rockwell Automation tests all of its products to ensure that they are fully operational when shipped from the manufacturing facility. However, if your product is not functioning and needs to be returned, follow these procedures.

United States	Contact your distributor. You must provide a Customer Support case number (call the phone number above to obtain one) to your distributor to complete the return process.
Outside United States	Please contact your local Rockwell Automation representative for the return procedure.

Documentation Feedback

Your comments will help us serve your documentation needs better. If you have any suggestions on how to improve this document, complete this form, publication [RA-DU002](#), available at <http://www.rockwellautomation.com/literature/>.

Rockwell Automation maintains current product environmental information on its website at <http://www.rockwellautomation.com/rockwellautomation/about-us/sustainability-ethics/product-environmental-compliance-page>.

Allen-Bradley, Rockwell Automation, FLEX I/O, Rockwell Software, and TechConnect are trademarks of Rockwell Automation, Inc. Trademarks not belonging to Rockwell Automation are property of their respective companies.

Rockwell Otomasyon Ticaret A.Ş., Kar Plaza İş Merkezi E Blok Kat:6 34752 İçerenköy, İstanbul, Tel: +90 (216) 5698400

www.rockwellautomation.com

Power, Control and Information Solutions Headquarters

Americas: Rockwell Automation, 1201 South Second Street, Milwaukee, WI 53204-2496 USA, Tel: (1) 414.382.2000, Fax: (1) 414.382.4444
Europe/Middle East/Africa: Rockwell Automation NV, Pegasus Park, De Kleerlaan 12a, 1831 Diegem, Belgium, Tel: (32) 2 663 0600, Fax: (32) 2 663 0640
Asia Pacific: Rockwell Automation, Level 14, Core F, Cyberport 3, 100 Cyberport Road, Hong Kong, Tel: (852) 2887 4788, Fax: (852) 2508 1846

Publication 1794-IN123D-EN-P - August 2018

Supersedes Publication 1794-IN123C-EN-P - July 2015

Copyright © 2018 Rockwell Automation, Inc. All rights reserved.