

## **FLEX I/O AC Digital Output Modules**

Catalog numbers 1794-OA8, 1794-OA8K, 1794-OA8I, 1794-OA16

### **Table of Contents**

<b>Topic</b>	<b>Page</b>
Important User Information	2
Environment and Enclosure	3
Preventing Electrostatic Discharge	3
European Hazardous Location Approval	5
North American Hazardous Location Approval	7
Install Your FLEX I/O AC Digital Output Module	8
Configure the FLEX I/O AC Output Module	15
Specifications	17

### Important User Information

Solid state equipment has operational characteristics differing from those of electromechanical equipment. Safety Guidelines for the Application, Installation and Maintenance of Solid State Controls (Publication [SGI-1.1](#) available from your local Rockwell Automation sales office or online at <http://www.rockwellautomation.com/literature/>) describes some important differences between solid state equipment and hard-wired electromechanical devices. Because of this difference, and also because of the wide variety of uses for solid state equipment, all persons responsible for applying this equipment must satisfy themselves that each intended application of this equipment is acceptable.

In no event will Rockwell Automation, Inc. be responsible or liable for indirect or consequential damages resulting from the use or application of this equipment.

The examples and diagrams in this manual are included solely for illustrative purposes. Because of the many variables and requirements associated with any particular installation, Rockwell Automation, Inc. cannot assume responsibility or liability for actual use based on the examples and diagrams.

No patent liability is assumed by Rockwell Automation, Inc. with respect to use of information, circuits, equipment, or software described in this manual.

Reproduction of the contents of this manual, in whole or in part, without written permission of Rockwell Automation, Inc. is prohibited.

Throughout this manual we use notes to make you aware of safety considerations.



**WARNING:** Identifies information about practices or circumstances that can cause an explosion in a hazardous environment, which may lead to personal injury or death, property damage, or economic loss.



**ATTENTION:** Identifies information about practices or circumstances that can lead to personal injury or death, property damage, or economic loss. Attentions help you identify a hazard, avoid a hazard, or recognize the consequence.

**IMPORTANT**

Identifies information that is critical for successful application and understanding of the product.

---

## Environment and Enclosure

---



**ATTENTION:** This equipment is intended for use in a Pollution Degree 2 industrial environment, in overvoltage Category II applications (as defined in EN/IEC 60664-1), at altitudes up to 2000 m (6562 ft) without derating.

This equipment is not intended for use in residential environments and may not provide adequate protection to radio communication services in such environments.

This equipment is supplied as open-type equipment for indoor use. It must be mounted within an enclosure that is suitably designed for those specific environmental conditions that will be present and appropriately designed to prevent personal injury resulting from accessibility to live parts. The enclosure must have suitable flame-retardant properties to prevent or minimize the spread of flame, complying with a flame spread rating of 5VA or be approved for the application if nonmetallic. The interior of the enclosure must be accessible only by the use of a tool. Subsequent sections of this publication may contain more information regarding specific enclosure type ratings that are required to comply with certain product safety certifications.

In addition to this publication, see the following:

- Industrial Automation Wiring and Grounding Guidelines, publication [1770-4.1](#), for more installation requirements.
- NEMA Standard 250 and EN/IEC 60529, as applicable, for explanations of the degrees of protection provided by enclosures.

---

## Preventing Electrostatic Discharge

---



**ATTENTION:** This equipment is sensitive to electrostatic discharge, which can cause internal damage and affect normal operation. Follow these guidelines when you handle this equipment:

- Touch a grounded object to discharge potential static.
  - Wear an approved grounding wriststrap.
  - Do not touch connectors or pins on component boards.
  - Do not touch circuit components inside the equipment.
  - Use a static-safe workstation, if available.
  - Store the equipment in appropriate static-safe packaging when not in use.
-

## 4 FLEX I/O AC Digital Output Modules

---

---



**ATTENTION:** This product is grounded through the DIN rail to chassis ground. Use zinc plated chromate-passivated steel DIN rail to assure proper grounding. The use of other DIN rail materials (for example, aluminum or plastic) that can corrode, oxidize, or are poor conductors, can result in improper or intermittent grounding. Secure DIN rail to mounting surface approximately every 200 mm (7.8 in.) and use end-anchors appropriately. Be sure to ground the DIN rail properly.

Refer to Industrial Automation Wiring and Grounding Guidelines, Rockwell Automation publication [1770-4.1](#), for more information

---

---



**ATTENTION:** If this equipment is used in a manner not specified by the manufacturer, the protection provided by the equipment may be impaired.

---

---



**ATTENTION:** If this equipment is used in a manner not specified by the manufacturer, the protection provided by the equipment may be impaired.

**ATTENTION:** Read this document and the documents listed in the Additional Resources section about installation, configuration, and operation of this equipment before you install, configure, operate, or maintain this product. Users are required to familiarize themselves with installation and wiring instructions in addition to requirements of all applicable codes, laws, and standards.

**ATTENTION:** Installation, adjustments, putting into service, use, assembly, disassembly, and maintenance are required to be carried out by suitably trained personnel in accordance with applicable code of practice. In case of malfunction or damage, no attempts at repair should be made. The module should be returned to the manufacturer for repair. Do not dismantle the module.

**ATTENTION:** Use only a soft dry anti-static cloth to wipe down equipment. Do not use any cleaning agents.

---

---



**WARNING:** When you insert or remove the module while backplane power is on, an electric arc can occur. This could cause an explosion in hazardous location installations.

Be sure that power is removed or the area is nonhazardous before proceeding. Repeated electric arcing causes excessive wear to contacts on both the module and its mating connector. Worn contacts may create electrical resistance that can affect module operation.

---



**WARNING:** If you insert or remove the module while backplane power is on, an electric arc can occur. This could cause an explosion in hazardous location installations.

Be sure that power is removed or the area is nonhazardous before proceeding.

---

## European Hazardous Location Approval

Approved for the 1794-OA8K module only.

---

### The following applies to products marked $\text{CE}$ II 3 G:

Are Equipment Group II, Equipment Category 3, and comply with the Essential Health and Safety Requirements relating to the design and construction of such equipment given in Annex II to EU Directive 2014/34/EU. See the EU Declaration of Conformity at <http://www.rockwellautomation.com/global/certification/overview.page> for details. The type of protection is II 3G Ex nA IIC T3 Gc according to EN 60079-15.

Comply to Standards EN 60079-0:2012, EN 60079-15:2010, reference certificate number LCIE 01 ATEX 6020 X.

Are intended for use in areas in which explosive atmospheres caused by gases, vapors, mists, or air are unlikely to occur, or are likely to occur only infrequently and for short periods. Such locations correspond to Zone 2 classification according to ATEX directive 2014/34/EU.

---





**WARNING: Observe the following additional certification requirements:**

- This equipment is not resistant to sunlight or other sources of UV radiation.
  - This equipment shall be mounted in an ATEX/IECEx Zone 2 certified enclosure with a minimum ingress protection rating of at least IP54 (in accordance with EN/IEC 60079-15) and used in an environment of not more than Pollution Degree 2 (as defined in EN/IEC 60664-1) when applied in Zone 2 environments. The enclosure must be accessible only by the use of a tool.
  - This equipment shall be used within its specified ratings defined by Rockwell Automation.
  - The instructions in the user manual shall be observed.
  - This equipment must be used only with ATEX certified Rockwell Automation backplanes.
  - Earthing is accomplished through mounting of modules on rail.
  - Devices shall be used in an environment of not more than Pollution Degree 2.
  - Enclosure must be marked with the following: "Warning - Do not open when energized." After installation of equipment into the enclosure, access to termination compartments shall be dimensioned so that conductors can be readily connected.
-

## North American Hazardous Location Approval

The following modules are North American Hazardous Location approved: 1794-OA8, 1794-OA8K, 1794-OA8I, 1794-OA16.

<b>The following information applies when operating this equipment in hazardous locations:</b>	<b>Informations sur l'utilisation de cet équipement en environnements dangereux:</b>
<p>Products marked "CL I, DIV 2, GP A, B, C, D" are suitable for use in Class I Division 2 Groups A, B, C, D, Hazardous Locations and nonhazardous locations only. Each product is supplied with markings on the rating nameplate indicating the hazardous location temperature code. When combining products within a system, the most adverse temperature code (lowest "T" number) may be used to help determine the overall temperature code of the system. Combinations of equipment in your system are subject to investigation by the local Authority Having Jurisdiction at the time of installation.</p>	<p>Les produits marqués "CL I, DIV 2, GP A, B, C, D" ne conviennent qu'à une utilisation en environnements de Classe I Division 2 Groupes A, B, C, D dangereux et non dangereux. Chaque produit est livré avec des marquages sur sa plaque d'identification qui indiquent le code de température pour les environnements dangereux. Lorsque plusieurs produits sont combinés dans un système, le code de température le plus défavorable (code de température le plus faible) peut être utilisé pour déterminer le code de température global du système. Les combinaisons d'équipements dans le système sont sujettes à inspection par les autorités locales qualifiées au moment de l'installation.</p>
<div style="display: flex; align-items: center;">  <div> <p><b>EXPLOSION HAZARD</b></p> <ul style="list-style-type: none"> <li>• Do not disconnect equipment unless power has been removed or the area is known to be nonhazardous.</li> <li>• Do not disconnect connections to this equipment unless power has been removed or the area is known to be nonhazardous. Secure any external connections that mate to this equipment by using screws, sliding latches, threaded connectors, or other means provided with this product.</li> <li>• Substitution of components may impair suitability for Class I, Division 2.</li> <li>• If this product contains batteries, they must only be changed in an area known to be nonhazardous.</li> </ul> </div> </div>	<div style="display: flex; align-items: center;">  <div> <p><b>RISQUE D'EXPLOSION</b></p> <ul style="list-style-type: none"> <li>• Couper le courant ou s'assurer que l'environnement est classé non dangereux avant de débrancher l'équipement.</li> <li>• Couper le courant ou s'assurer que l'environnement est classé non dangereux avant de débrancher les connecteurs. Fixer tous les connecteurs externes reliés à cet équipement à l'aide de vis, loquets coulissants, connecteurs filetés ou autres moyens fournis avec ce produit.</li> <li>• La substitution de composants peut rendre cet équipement inadapté à une utilisation en environnement de Classe I, Division 2.</li> <li>• S'assurer que l'environnement est classé non dangereux avant de changer les piles.</li> </ul> </div> </div>

## Install Your FLEX I/O AC Digital Output Module

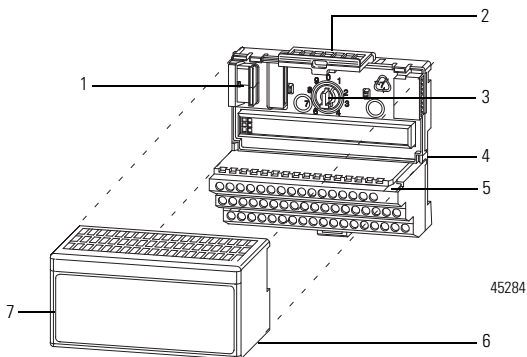

	Description		Description
1	Flexbus connector	5	Groove
2	Latching mechanism	6	Alignment bar
3	Keyswitch	7	Module
4	Terminal base		

The module mounts on a 1794 terminal base.



**WARNING:** 1794-TBNF and 1794-TBNFK are not approved for Class I Division 2 Applications.

1. Rotate the keyswitch (3) on the terminal base (4) clockwise to position 8 as required for this type of module.
2. Make sure the Flexbus connector (1) is pushed all the way to the left to connect with the neighboring terminal base/adapter.  
**You cannot install the module unless the connector is fully extended.**
3. Make sure the pins on the bottom of the module are straight so they will align properly with the connector in the terminal base.
4. Position the module (7) with its alignment bar (6) aligned with the groove (5) on the terminal base.



5. Press firmly and evenly to seat the module in the terminal base unit. The module is seated when the latching mechanism (2) is locked into the module.

## Connecting Wiring for the 1794-OA8 or 1794-OA8K

1. **For 1794-TB2, 1794-TB3, or 1794-TB3S** – Connect individual output wiring to even numbered terminals on the 0...15 row (A) as indicated in the Wiring Connections for 1794-OA8 and 1794-OA8K table.
2. **For 1794-TBN or 1794-TBNF** – Connect individual output wiring to even numbered terminals on the 16...33 row (B) as indicated in the Wiring Connections for 1794-OA8 and 1794-OA8K table.
3. **For 1794-TB2, 1794-TB3, or 1794-TB3S** – Connect the associated V AC common (L2) lead of the output device to the corresponding odd numbered terminal on the 0...15 row (A) for each output as indicated in the Wiring Connections for 1794-OA8 and 1794-OA8K table; or to the corresponding terminal on the 16...33 row (B). The V AC common (L2) terminals of row (B) and the odd numbered terminals of row (A) are internally connected together. **For 1794-TBN or 1794-TBNF** – Connect the associated V AC common (L2) lead of the output device to the corresponding odd numbered terminal on the 34...51 row (C) for each output as indicated in the Wiring Connections for 1794-OA8 and 1794-OA8K table. The odd numbered terminals of row (C) are internally connected together to V AC L2 common.
4. Connect V AC power L1 to terminal 34 on the 34...51 row (C).
5. Connect V AC common L2 to terminal 16 on the 16...33 row (B).
6. If daisy chaining V AC power (L1) to the next terminal base, connect a jumper from terminal 51 (V AC L1) on this base unit to terminal 34 on the next base unit.
7. If continuing V AC common (L2) to the next base unit, connect a jumper from terminal 33 (V common L2) on this base unit to terminal 16 on the next base unit.

---

**IMPORTANT** Total current draw through terminal base connection is limited to 10 A. Separate power connections to each terminal base may be necessary.

---



**ATTENTION:** If multiple power sources are used for 1794-OA8I, do not exceed the specified isolation voltage.

---

### Wiring Connections for 1794-0A8 and 1794-0A8K

Output <sup>(1)</sup>	1794-TB2, 1794-TB3, 1794-TB3S		1794-TBN, 1794-TBNF	
	Output Terminal	Common Terminal (L2) <sup>(1)</sup>	Output Terminal	Common Terminal (L2) <sup>(2)</sup>
0	A-0	A-1/B-17	B-0	C-1
1	A-2	A-3/B-19	B-2	C-3
2	A-4	A-5/B-21	B-4	C-5
3	A-6	A-7/B-23	B-6	C-7
4	A-8	A-9/B-25	B-8	C-9
5	A-10	A-11/B-27	B-10	C-11
6	A-12	A-13/B-29	B-12	C-13
7	A-14	A-15/B-31	B-14	C-15

A = Output terminals (Even numbered terminals 0...14)  
 B = Common terminals  
 C = Power terminals (C-34 and C-51 on 1794-TB2; C-34...C-51 on 1794-TB3 and 1794-TB3S)

B = Even numbered output terminals 0...14, AC common terminals 16 and 33  
 C = Power terminals C-34 and C-51, and odd numbered output terminals 1...15

- (1) A-1, 3, 5, 7, 9, 11, 13, and 15 on the 1794-TB2, 1794-TB3, and 1794-TB3S are internally connected in the module to 120V AC common (L2).
- (2) C-1, 3, 5, 7, 9, 11, 13, and 15 on the 1794-TBN and 1794-TBNF are internally connected in the module to 120V AC common (L2).

### 1794-TB2, 1794-TB3, and 1794-TB3S Terminal Base Wiring for 1794-0A8

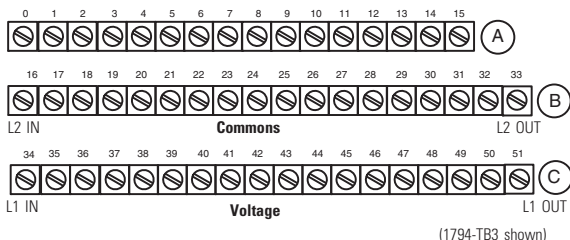

Connect 120V AC common L2 to terminal B-16.

Connect 120V AC power L1 to terminal C-34.

(Use B-33 and C-51 for daisy-chaining power to the next terminal base unit.)

(Terminals C-35...C-50 are not present on the 1794-TB2.)

45671

## 1794-TBN and 1794-TBNF Terminal Base Wiring for 1794-OA8

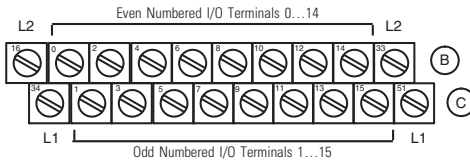

Connect 120V AC (L2) to terminal B-16

Connect 120V AC power (L1) to terminal C-34

Use B-33 and C-31 for daisy chaining to the next terminal base

45672

### Connect Wiring for the 1794-OA8I

- For 1794-TB2, 1794-TB3, or 1794-TB3S** – Connect individual output wiring to the even numbered terminals on the 0...15 row (A).  
**For 1794-TBN or 1794-TBNF** – Connect individual output wiring to the even numbered terminals on the 16...33 row (B).
- For 1794-TB2, 1794-TB3, or 1794-TB3S** – Connect the associated V AC power lead (L1) to the corresponding odd numbered terminal on the 0...15 row (A) for each output as indicated in the Wiring Connections for 1794-OA8I table.  
**For 1794-TBN or 1794-TBNF** – Connect the associated VAC power (L1) lead to the odd numbered terminals on row (C).

**IMPORTANT** Individual isolated 120V AC common (L2) leads must be run externally to each output device.



**WARNING:** When used in a Class I, Division 2, hazardous location, this equipment must be mounted in a suitable enclosure with proper wiring method that complies with the governing electrical codes.

### Wiring Connections for 1794-0A8I

Output <sup>(1)</sup>	1794-TB2, 1794-TB3, 1794-TB3S		1794-TBN, 1794-TBNF	
	Output Terminal	120V AC Supply <sup>(1)</sup>	Output Terminal	120V AC Supply <sup>(2)</sup>
0	A-0	A-1	B-0	C-1
1	A-2	A-3	B-2	C-3
2	A-4	A-5	B-4	C-5
3	A-6	A-7	B-6	C-7
4	A-8	A-9	B-8	C-9
5	A-10	A-11	B-10	C-11
6	A-12	A-13	B-12	C-13
7	A-14	A-15	B-14	C-15

<sup>(1)</sup> A = Even numbered terminals 0...14 for customer connections; corresponding odd numbered 120V AC supply L1 terminals 1...15 for customer connections from isolated power supply.

<sup>(2)</sup> B = Even numbered terminals 0...14 for customer connections; C = Odd numbered 120V AC supply L1 terminals 1...15 for customer connections from isolated power supply.

### 1794-TB2, 1794-TB3, and 1794-TB3S Terminal Base Wiring for 1794-0A8I

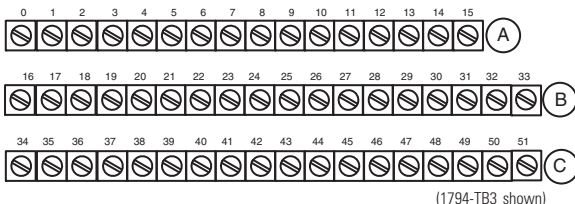

Connect outputs to even numbered terminals on row (A)

Connect isolated 120V AC (L1) to odd numbered terminals on row (A)

Individual isolated 120V AC common (L2) must be run externally to each of the output devices (Terminals C-35...C-50 are not available on the 1794-TB2.)

45673

## 1794-TBN and 1794-TBNF Terminal Base Wiring for 1794-OA8I

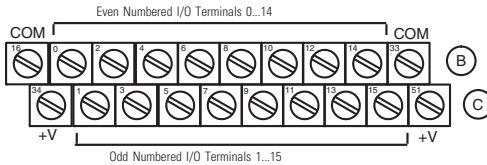

Connect outputs to even numbered terminals on row (B).  
 Connect isolated 120V AC (L1) to odd numbered terminals on row (C).  
 Individual isolated 120V AC common (L2) must be run externally to each  
 of the output devices.

45674

## Connect Wiring for the 1794-OA16

- For 1794-TB2, 1794-TB3, or 1794-TB3S** – Connect individual output wiring to numbered terminals on the 0...15 row (A) as indicated in the Wiring Connections for 1794-OA16 table.

**For 1794-TBN** – Connect individual output wiring to terminals 0...15 on rows B and C.
- For 1794-TB2, 1794-TB3, or 1794-TB3S** – Connect the associated VAC common (L2) lead of the output device to the corresponding numbered terminal on the 16...33 row (B) for each output as indicated in the Wiring Connections for 1794-OA16 table. The V AC common terminals of row (B) are internally connected together.

**For 1794-TBN** – Auxiliary terminal blocks are required to connect the associated L2 common for each channel. Connect the L2 side of the load together and then connect to L2 on the power supply.
- Connect 120V AC power L1 to terminal 34 on the 34...51 row (C).
- Connect 120V AC common L2 to terminal 16 on the 16...33 row (B).
- If daisychaining power to the next terminal base, connect a jumper from terminal 51 (120V AC L1) on this base unit to terminal 34 on the next base unit.
- If continuing 120V AC common (L2) to the next base unit, connect a jumper from terminal 33 (120V AC common L2) on this base unit to terminal 16 on the next base unit.

---

**IMPORTANT** Total current draw through terminal base connection is limited to 10 A.  
 Separate power connections to each terminal base may be necessary.

---

## 14 FLEX I/O AC Digital Output Modules



At the end of its life, this equipment should be collected separately from any unsorted municipal waste.

### Wiring Connections for 1794-0A16

Output Channel	1794-TB2, 1794-TB3, 1794-TB3S		1794-TBN
	Output Terminal	120V AC Common (L2)	Output Terminal <sup>(1)</sup>
0	A-0	B-17	B-0
1	A-1	B-18	C-1
2	A-2	B-19	B-2
3	A-3	B-20	C-3
4	A-4	B-21	B-4
5	A-5	B-22	C-5
6	A-6	B-23	B-6
7	A-7	B-24	C-7
8	A-8	B-25	B-8
9	A-9	B-26	C-9
10	A-10	B-27	B-10
11	A-11	B-28	C-11
12	A-12	B-29	B-12
13	A-13	B-30	C-13
14	A-14	B-31	B-14
15	A-15	B-32	C-15
120V AC L1 power	Connect V AC L1 to C-34. <b>1794-TB3, 1794-TB3S</b> – Power terminals C-34...C-51 are internally connected together. <b>1794-TB2 and 1794-TBN</b> – C-34 and C-51 are internally connected together.		
120V AC L2	Connect 120V AC common L2 to terminal B-16. <b>1794-TB3, 1794-TB3S</b> – 120V AC common L2 terminals B-16...B-33 are internally connected together. <b>1794-TB2, 1794-TBN</b> – 120V AC common L2 terminals B-16 and B-33 internally connected together.		

<sup>(1)</sup> Auxiliary terminal blocks are required to connect the associated L2 common for each channel when using a 1794-TBN terminal base with the 1794-0A16.



## 16 FLEX I/O AC Digital Output Modules

### Image Table Memory Map for the 1794-0A16 Module

<b>Dec</b>	<b>15</b>	<b>14</b>	<b>13</b>	<b>12</b>	<b>11</b>	<b>10</b>	<b>9</b>	<b>8</b>	<b>7</b>	<b>6</b>	<b>5</b>	<b>4</b>	<b>3</b>	<b>2</b>	<b>1</b>	<b>0</b>
<b>Oct</b>	<b>17</b>	<b>16</b>	<b>15</b>	<b>14</b>	<b>13</b>	<b>12</b>	<b>11</b>	<b>10</b>	<b>7</b>	<b>6</b>	<b>5</b>	<b>4</b>	<b>3</b>	<b>2</b>	<b>1</b>	<b>0</b>
Read	Not used – set to 0															
Write	015	014	013	012	011	010	09	08	07	06	05	04	03	02	01	00
Where	0 = Output number															



## Specifications

### Specifications – 1794-OA8, 1794-OA8K, 1794-OA8I

Attribute	1794-OA8, 1794-OA8K	1794-OA8I
Number of outputs	8, nonisolated	8, isolated
Recommended terminal base unit	1794-TBN <sup>(4)</sup> , 1794-TBNF, 1794-TB2, 1794-TB3, 1794-TB3S, 1794-TBKD, 1794-TBNK, 1794-TBNFK, 1794-TB3K, 1794-TB3SK	
Output voltage, min	85V AC	
Output voltage, nom	120V AC	
Output voltage, max	132V AC	
Output current rating	4.0 A (8 outputs @ 500 mA)	
On-state current, min	5.0 mA per output	
On-state current, max <sup>(1)</sup>	500 mA per output @ 55 °C (sufficient to operate an Allen-Bradley Bulletin 500 NEMA size 3 motor starter) 750 mA per output @ 35 °C 1.0 A on 4 non-adjacent outputs, 500 mA on the remaining 4 outputs @ 30 °C	
On-state voltage drop, max	1.0V @ 0.5 A	
Surge current	7 A for 40 ms, repeatable every 8 seconds	
Off-state leakage current, max	2.25 mA	
Isolation voltage	120V (continuous), field to backplane Tested @ 1250V AC for 60 s No isolation between individual channels.	120V (continuous), field to backplane, channel to channel Tested @ 1250V AC for 60 s Isolation between individual channels.
Output signal delay <sup>(2)</sup> Off to On On to Off	1/2 cycle max 1/2 cycle max	
FlexBus current	80 mA @ 5V DC	
Power dissipation, max	4.1 W @ 0.5 A 6.3 W @ 0.75 A 6.3 W @ 1.0 A	
Thermal dissipation, max	14.0 BTU/hr @ 0.5 A 21.2 BTU/hr @ 0.75 A 21.4 BTU/hr @ 1.0 A	
Fusing <sup>(3)</sup>	1.6 A, 250V AC slow-blow, Littelfuse 23901.6; San-O SD6-1.6 (1.6 A fuses come preinstalled in 1794-TBNF terminal base units.)	

<sup>(1)</sup> Below 50 mA the voltage drop across the module will be higher and the voltage waveform may have some small oscillation (less than 5V).

## 18 FLEX I/O AC Digital Output Modules

- (2) Output signal delay is the time from receipt of an output on or off command to the output actually turning on or off.
- (3) Module outputs are not fused. Fusing is recommended. If fusing is desired, you must supply external fusing or use the 1794-TBNF terminal base, if recommended.
- (4) Auxiliary terminal strips are required when using the 1794-TBN.

### Specifications – 1794-OA16

Attribute	Value
Number of outputs	16, nonisolated
Recommended terminal base unit	1794-TBN <sup>(5)</sup> , 1794-TBNF, 1794-TB2, 1794-TB3, 1794-TB3S, 1794-TBKD, 1794-TBNK, 1794-TBNFK, 1794-TB3K, 1794-TB3SK
Mounting	See derating curve
Output voltage range, min	74V AC
Output voltage range, nom	120V AC
Output voltage range, max	132V AC
Output current rating <sup>(1)</sup>	4.0 A (16 outputs @ 250 mA)
On-state current, min	5.0 mA per output
On-state current, max <sup>(2)</sup>	500 mA per output @ 55 °C
On-state voltage drop, max	1.5V @ 0.5 A
Surge current	7 A for 40 ms, repeatable every 8 seconds
Off-state leakage current, max	2.25 mA
Isolation voltage	120V (continuous), field to backplane Tested @ 1250V AC for 60 s No isolation between individual channels.
Output signal delay <sup>(3)</sup> Off to On On to Off	1/2 cycle max 1/2 cycle max
FlexBus current	80 mA @ 5V DC
Power dissipation, max	4.7 W @ 0.5 A
Thermal dissipation, max	16.1 BTU/hr @ 0.5 A
Fusing <sup>(4)</sup>	2.5 A, 150V AC normal blow, MQ2

- (1) If using 0.5 A outputs, alternate wiring so that no two 0.5 A outputs are next to each other.
- (2) Below 50 mA the voltage drop across the module will be higher and the voltage waveform may have some small oscillation (less than 5V).
- (3) Output signal delay is the time from receipt of an output on or off command to the output actually turning on or off.

- (4) Module outputs are not fused. Fusing is recommended. If fusing is desired, you must supply external fusing or use the 1794-TBNF terminal base, if recommended.
- (5) Auxiliary terminal strips are required when using the 1794-TBN.

## General Specifications

Attribute	Value
Terminal base screw torque	Determined by installed terminal base
Dimensions, approx. (H x W x D)	94 x 94 x 69 mm (3.7 x 3.7 x 2.7 in.)
Weight, approx.	109 g (3.84 oz) – <b>1794-0A8, 1794-0A8K</b> 107 g (3.77 oz.) – <b>1794-0A8I</b> 96 g (3.38 oz.) – <b>1794-0A16</b>
Indicators (field side indication)	8 yellow status indicators – <b>1794-0A8, 1794-0A8K, 1794-0A8I</b> 16 yellow status indicators – <b>1794-0A16</b>
External AC power supply voltage	120V AC
External AC power voltage range	85...132V AC – <b>1794-0A8, 1794-0A8K, 1794-0A8I</b> 74...132V AC – <b>1794-0A16</b>
Keyswitch position	8
Pilot duty rating	5 A Inrush
North American temp code	T4A – <b>1794-0A8, 1794-0A8K, 1794-0A8I</b> T4 – <b>1794-0A16</b>
IEC temp code	T4 – <b>1794-0A8K</b>
Enclosure type rating	None (open-style)
Wire size	Determined by installed terminal base
Wiring category <sup>(1)</sup>	2 - on signal ports

- (1) Use this conductor category information for planning conductor routing as described in Industrial Automation Wiring and Grounding Guidelines, publication [1770-4.1](#).

## Environmental Specifications

Attribute	Value
Operating temperature	IEC 60068-2-1 (Test Ad, Operating Cold), IEC 60068-2-2 (Test Bd, Operating Dry Heat), IEC 60068-2-14 (Test Nb, Operating Thermal Shock): -20...55 °C (-4...131 °F) – <b>1794-0A8, 1794-0A8K, 1794-0A8I</b> 0 °C < Ta < +55 °C (+32 °F < Ta < +131 °F) – <b>1794-0A16</b>
Temperature, surrounding air, max.	55 °C (131 °F)
Temperature, nonoperating	IEC 60068-2-1 (Test Ab, Unpackaged Non-operating Cold), IEC 60068-2-2 (Test Bb, Unpackaged Non-operating Dry Heat), IEC 60068-2-14 (Test Na, Unpackaged Non-operating Thermal Shock): -40...85 °C (-40...185 °F)
Relative humidity	IEC 60068-2-30 (Test Db, Unpackaged Damp Heat): 5...95% non-condensing
Vibration	IEC60068-2-6 (Test Fc, Operating): 5 g @ 10...500 Hz
Shock, operating	IEC60068-2-27 (Test Ea, Unpackaged shock): 30 g
Shock, nonoperating	IEC60068-2-27 (Test Ea, Unpackaged shock): 50 g
Emissions	IEC 61000-6-4
ESD immunity	IEC 61000-4-2: 6kV contact discharges 8 kV air discharges
Radiated RF immunity	IEC 61000-4-3: 10V/m with 1 kHz sine-wave 80% AM from 80...2000 MHz 10V/m with 200 Hz 50% Pulse 100% AM @ 900 MHz 10V/m with 200 Hz 50% Pulse 100% AM @ 1890 MHz 1V/m with 1 kHz sine-wave 80% AM from 2000...2700 MHz
EFT/B immunity	IEC 61000-4-4: ±2 kV @ 5 kHz on power ports ±2 kV @ 5 kHz on signal ports
Surge transient immunity	IEC 61000-4-5: ±1 kV line-line(DM) and ±2 kV line-earth(CM) on signal ports
Conducted RF immunity	IEC 61000-4-6: 10V rms with 1 kHz sine-wave 80% AM from 150 kHz...80 MHz

## Certifications



Certifications (when product is marked) <sup>(1)</sup>	Value
c-UL-us	<p><b>1794-0A8, 179-0A8K, 1794-0A8I</b>            UL Listed Industrial Control Equipment.            See UL File E65584.</p> <p><b>1794-0A16</b>            UL Listed Industrial Control Equipment, certified for US and Canada.            See UL File E322657.</p> <p>UL Listed for Class I, Division 2 Group A,B,C,D Hazardous Locations, certified for U.S. and Canada. See UL File E334470.</p>
CSA	<p><b>1794-0A8, 1794-0A8K, 1794-0A8I</b>            CSA Certified Process Control Equipment. See CSA File LR54689C.            CSA Certified Process Control Equipment for Class I, Division 2 Group A,B,C,D Hazardous Locations. See CSA File LR69960C.</p>
CE	<p>European Union 2014/30/EU EMC Directive, compliant with:            EN 61326-1; Meas./Control/Lab., Industrial Requirements            EN 61000-6-2; Industrial Immunity            EN 61000-6-4; Industrial Emissions            EN 61131-2; Programmable Controllers (Clause 8, Zone A &amp; B)</p> <p>European Union 2014/35/EU LVD, compliant with:            EN 61131-2; Programmable Controllers (Clause 11)</p> <p><b>1794-0A16</b>            European Union 2011/65/EU RoHS, compliant with:            EN 50581; Technical documentation</p>
Ex	<p><b>1794-0A8K</b>            European Union 94/9/EC ATEX Directive, compliant with:            EN 60079-15:2010; Potentially Explosive Atmospheres, Protection "n"            EN 60079-0:2009; General Requirements            LCIE 01ATEX6020X II 3 G Ex nA IIC T4 Gc</p>
KC	<p>Korean Registration of Broadcasting and Communications Equipment, compliant with: Article 58-2 of Radio Waves Act, Clause 3</p>
EAC	<p>Russian Customs Union TR CU 020/2011 EMC Technical Regulation            Russian Customs Union TR CU 004/2011 LV Technical Regulation</p>
RCM	<p>Australian Radiocommunications Act, compliant with:            AS/NZS CISPR 11; EN 61000-6-4; Industrial Emissions</p>

<sup>(1)</sup> See the Product Certification link at <http://www.rockwellautomation.com/global/certification/overview.page> for Declarations of Conformity, Certificates, and other certification details.

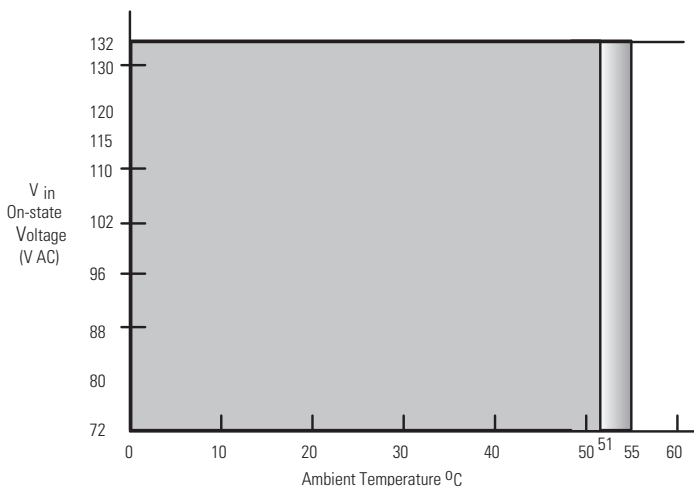
### Derating Curve for 1794-0A16



The area within the curve represents the safe operating range for the module under various conditions of user supplied 120V AC supply voltages and ambient temperatures.

-  = Normal mounting safe operating range. Includes 
-  = Other mounting positions (including inverted horizontal, vertical) safe operating range

Mounting	Temperature, max.
Normal horizontal	55 °C
Other mounting positions (including inverted horizontal, vertical)	51 °C

**Notes:**

## Rockwell Automation Support

Rockwell Automation provides technical information on the Web to assist you in using its products. At <http://www.rockwellautomation.com/support/>, you can find technical manuals, a knowledge base of FAQs, technical and application notes, sample code and links to software service packs, and a MySupport feature that you can customize to make the best use of these tools.

For an additional level of technical phone support for installation, configuration and troubleshooting, we offer TechConnect support programs. For more information, contact your local distributor or Rockwell Automation representative, or visit <http://www.rockwellautomation.com/support/>.

## Installation Assistance

If you experience a problem within the first 24 hours of installation, please review the information that's contained in this manual. You can also contact a special Customer Support number for initial help in getting your product up and running.

United States or Canada	1.440.646.3434
Outside United States or Canada	Use the <a href="#">Worldwide Locator</a> at <a href="http://www.rockwellautomation.com/support/americas/phone_en.html">http://www.rockwellautomation.com/support/americas/phone_en.html</a> , or contact your local Rockwell Automation representative.

## New Product Satisfaction Return

Rockwell Automation tests all of its products to ensure that they are fully operational when shipped from the manufacturing facility. However, if your product is not functioning and needs to be returned, follow these procedures.

United States	Contact your distributor. You must provide a Customer Support case number (call the phone number above to obtain one) to your distributor to complete the return process.
Outside United States	Please contact your local Rockwell Automation representative for the return procedure.

## Documentation Feedback

Your comments will help us serve your documentation needs better. If you have any suggestions on how to improve this document, complete this form, publication [RA-DU002](#), available at <http://www.rockwellautomation.com/literature/>.

Allen-Bradley, Rockwell Automation, FLEX I/O, Rockwell Software and TechConnect are trademarks of Rockwell Automation, Inc.

Trademarks not belonging to Rockwell Automation are property of their respective companies.

Rockwell Otomasyon Ticaret A.Ş., Kar Plaza İş Merkezi E Blok Kat:6 34752 İçerenköy, İstanbul, Tel: +90 (216) 5698400

[www.rockwellautomation.com](http://www.rockwellautomation.com)

### Power, Control and Information Solutions Headquarters

Americas: Rockwell Automation, 1201 South Second Street, Milwaukee, WI 53204-2496 USA, Tel: (1) 414.382.2000, Fax: (1) 414.382.4444  
Europe/Middle East/Africa: Rockwell Automation NV, Pegasus Park, De Kleeflaan 12a, 1831 Diegem, Belgium, Tel: (32) 2 663 0600, Fax: (32) 2 663 0640  
Asia Pacific: Rockwell Automation, Level 14, Core F, Cyberport 3, 100 Cyberport Road, Hong Kong, Tel: (852) 2887 4788, Fax: (852) 2508 1846

Publication 1794-IN103D-EN-P - July 2018

Supersedes Publication 1794-IN103C-EN-P - July 2015

Copyright © 2018 Rockwell Automation, Inc. All rights reserved.