

FLEX I/O Digital DC Output Modules

Catalog numbers 1794-OB8, 1794-OB8EP, 1794-OB16,
1794-OB16P, 1794-OB32P

Table of Contents

Topic	Page
Important User Information	2
Environment and Enclosure	3
Preventing Electrostatic Discharge	3
European Hazardous Location Approval	3
North American Hazardous Location Approval	7
Install Your FLEX I/O AC Digital Output Module	8
Connect Wiring for 1794-OB8, 1794-OB8EP, 1794-OB16, and 1794-OB16P	9
Connect Wiring for the 1794-OB32P	11
Configuring your 1794-OB8EP Output Module	14
Configure the 1794-OB8, 1794-OB16, 1794-OB16P, 1794-OB32P Modules	15
Specifications	16

Important User Information

Solid-state equipment has operational characteristics differing from those of electromechanical equipment. Safety Guidelines for the Application, Installation, and Maintenance of Solid-State Controls (Publication [SGI-1.1](#) available from your local Rockwell Automation Sales Office or online at <http://www.rockwellautomation.com/literature/>) describes some important differences between solid state equipment and hard-wired electromechanical devices. Because of this difference, and also because of the wide variety of uses for solid state equipment, all persons responsible for applying this equipment must satisfy themselves that each intended application of this equipment is acceptable.

In no event will Rockwell Automation, Inc. be responsible or liable for indirect or consequential damages resulting from the use or application of this equipment.

The examples and diagrams in this manual are included solely for illustrative purposes. Because of the many variables and requirements associated with any particular installation, Rockwell Automation, Inc. cannot assume responsibility or liability for actual use based on the examples and diagrams.

No patent liability is assumed by Rockwell Automation, Inc. with respect to use of information, circuits, equipment, or software described in this manual.

Reproduction of the contents of this manual, in whole or in part, without written permission of Rockwell Automation, Inc. is prohibited.

Throughout this manual we use notes to make you aware of safety considerations.



WARNING: Identifies information about practices or circumstances that can cause an explosion in a hazardous environment, which may lead to personal injury or death, property damage, or economic loss.



ATTENTION: Identifies information about practices or circumstances that can lead to personal injury or death, property damage, or economic loss. Attentions help you identify a hazard, avoid a hazard, and recognize the consequences.

IMPORTANT

Identifies information that is critical for successful application and understanding of the product.

Environment and Enclosure



ATTENTION: This equipment is intended for use in a Pollution Degree 2 industrial environment, in overvoltage Category II applications (as defined in EN/IEC 60664-1), at altitudes up to 2000 m (6562 ft) without derating.

This equipment is not intended for use in residential environments and may not provide adequate protection to radio communication services in such environments.

This equipment is supplied as open-type equipment for indoor use. It must be mounted within an enclosure that is suitably designed for those specific environmental conditions that will be present and appropriately designed to prevent personal injury resulting from accessibility to live parts. The enclosure must have suitable flame-retardant properties to prevent or minimize the spread of flame, complying with a flame spread rating of 5VA or be approved for the application if nonmetallic. The interior of the enclosure must be accessible only by the use of a tool. Subsequent sections of this publication may contain more information regarding specific enclosure type ratings that are required to comply with certain product safety certifications.

In addition to this publication, see the following:

- Industrial Automation Wiring and Grounding Guidelines, publication [1770-4.1](#), for more installation requirements.
- NEMA Standard 250 and EN/IEC 60529, as applicable, for explanations of the degrees of protection provided by enclosures.

Preventing Electrostatic Discharge



ATTENTION: This equipment is sensitive to electrostatic discharge, which can cause internal damage and affect normal operation. Follow these guidelines when you handle this equipment:

- Touch a grounded object to discharge potential static.
 - Wear an approved grounding wriststrap.
 - Do not touch connectors or pins on component boards.
 - Do not touch circuit components inside the equipment.
 - Use a static-safe workstation, if available.
 - Store the equipment in appropriate static-safe packaging when not in use.
-

4 FLEX I/O Digital DC Output Modules



ATTENTION: This product is grounded through the DIN rail to chassis ground. Use zinc plated chromate-passivated steel DIN rail to assure proper grounding. The use of other DIN rail materials (for example, aluminum or plastic) that can corrode, oxidize, or are poor conductors, can result in improper or intermittent grounding. Secure DIN rail to mounting surface approximately every 200 mm (7.8 in.) and use end-anchors appropriately. Be sure to ground the DIN rail properly.

Refer to Industrial Automation Wiring and Grounding Guidelines, Rockwell Automation publication [1770-4.1](#), for more information.



ATTENTION: If this equipment is used in a manner not specified by the manufacturer, the protection provided by the equipment may be impaired.



ATTENTION: If this equipment is used in a manner not specified by the manufacturer, the protection provided by the equipment may be impaired.

ATTENTION: Read this document and the documents listed in the Additional Resources section about installation, configuration, and operation of this equipment before you install, configure, operate, or maintain this product. Users are required to familiarize themselves with installation and wiring instructions in addition to requirements of all applicable codes, laws, and standards.

ATTENTION: Installation, adjustments, putting into service, use, assembly, disassembly, and maintenance are required to be carried out by suitably trained personnel in accordance with applicable code of practice.

In case of malfunction or damage, no attempts at repair should be made. The module should be returned to the manufacturer for repair. Do not dismantle the module.

ATTENTION: Use only a soft dry anti-static cloth to wipe down equipment. Do not use any cleaning agents.



WARNING: When you insert or remove the module while backplane power is on, an electric arc can occur. This could cause an explosion in hazardous location installations.

Be sure that power is removed or the area is nonhazardous before proceeding. Repeated electric arcing causes excessive wear to contacts on both the module and its mating connector. Worn contacts may create electrical resistance that can affect module operation.



WARNING: If you insert or remove the module while backplane power is on, an electric arc can occur. This could cause an explosion in hazardous location installations.

Be sure that power is removed or the area is nonhazardous before proceeding.



At the end of its life, this equipment should be collected separately from any unsorted municipal waste.

European Hazardous Location Approval

Approved for 1794-OB8, 1794-OB8EP, 1794-OB16 and 1794-OB16P modules..

The following applies to products marked CE II 3 G:

Are Equipment Group II, Equipment Category 3, and comply with the Essential Health and Safety Requirements relating to the design and construction of such equipment given in Annex II to EU Directive 2014/34/EU. See the EU Declaration of Conformity at <http://www.rockwellautomation.com/global/certification/overview.page> for details.

The type of protection is II 3G Ex nA IIC T3 Gc according to EN 60079-15.

Comply to Standards EN 60079-0:2012, EN 60079-15:2010, reference certificate number LCIE 01 ATEX 6020 X.

Are intended for use in areas in which explosive atmospheres caused by gases, vapors, mists, or air are unlikely to occur, or are likely to occur only infrequently and for short periods. Such locations correspond to Zone 2 classification according to ATEX directive 2014/34/EU.





WARNING: Observe the following additional certification requirements:

- This equipment is not resistant to sunlight or other sources of UV radiation.
 - This equipment shall be mounted in an ATEX/IECEx Zone 2 certified enclosure with a minimum ingress protection rating of at least IP54 (in accordance with EN/IEC 60079-15) and used in an environment of not more than Pollution Degree 2 (as defined in EN/IEC 60664-1) when applied in Zone 2 environments. The enclosure must be accessible only by the use of a tool.
 - This equipment shall be used within its specified ratings defined by Rockwell Automation.
 - The instructions in the user manual shall be observed.
 - This equipment must be used only with ATEX certified Rockwell Automation backplanes.
 - Earthing is accomplished through mounting of modules on rail.
 - Devices shall be used in an environment of not more than Pollution Degree 2.
 - Enclosure must be marked with the following: "Warning - Do not open when energized." After installation of equipment into the enclosure, access to termination compartments shall be dimensioned so that conductors can be readily connected.
-

North American Hazardous Location Approval

The 1794-OB8, 1794-OB8EP, 1794-OB16, 1794-OB16P module is Hazardous Location approved:

The following information applies when operating this equipment in hazardous locations:	Informations sur l'utilisation de cet équipement en environnements dangereux:
<p>Products marked "CL I, DIV 2, GP A, B, C, D" are suitable for use in Class I Division 2 Groups A, B, C, D, Hazardous Locations and nonhazardous locations only. Each product is supplied with markings on the rating nameplate indicating the hazardous location temperature code. When combining products within a system, the most adverse temperature code (lowest "T" number) may be used to help determine the overall temperature code of the system. Combinations of equipment in your system are subject to investigation by the local Authority Having Jurisdiction at the time of installation.</p>	<p>Les produits marqués "CL I, DIV 2, GP A, B, C, D" ne conviennent qu'à une utilisation en environnements de Classe I Division 2 Groupes A, B, C, D dangereux et non dangereux. Chaque produit est livré avec des marquages sur sa plaque d'identification qui indiquent le code de température pour les environnements dangereux. Lorsque plusieurs produits sont combinés dans un système, le code de température le plus défavorable (code de température le plus faible) peut être utilisé pour déterminer le code de température global du système. Les combinaisons d'équipements dans le système sont sujettes à inspection par les autorités locales qualifiées au moment de l'installation.</p>
<div data-bbox="114 609 199 684" style="text-align: center;">  </div> <p>WARNING: EXPLOSION HAZARD</p> <ul style="list-style-type: none"> • Do not disconnect equipment unless power has been removed or the area is known to be nonhazardous. • Do not disconnect connections to this equipment unless power has been removed or the area is known to be nonhazardous. Secure any external connections that mate to this equipment by using screws, sliding latches, threaded connectors, or other means provided with this product. • Substitution of components may impair suitability for Class I, Division 2. 	<div data-bbox="515 609 600 684" style="text-align: center;">  </div> <p>WARNING: RISQUE D'EXPLOSION</p> <ul style="list-style-type: none"> • Couper le courant ou s'assurer que l'environnement est classé non dangereux avant de débrancher l'équipement. • Couper le courant ou s'assurer que l'environnement est classé non dangereux avant de débrancher les connecteurs. Fixer tous les connecteurs externes reliés à cet équipement à l'aide de vis, loquets coulissants, connecteurs filetés ou autres moyens fournis avec ce produit. • La substitution de composants peut rendre cet équipement inadapté à une utilisation en environnement de Classe I, Division 2.

Install Your FLEX I/O AC Digital Output Module

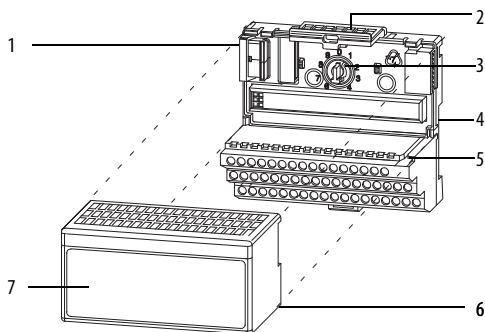

	Description		Description
1	Flexbus connector	5	Groove
2	Latching mechanism	6	Alignment bar
3	Keyswitch	7	Module
4	Terminal base		

The module mounts on a 1794 terminal base.

1. Rotate the keyswitch (3) on the terminal base (4) clockwise to position 2 as required for this type of module.
2. Make sure the Flexbus connector (1) is pushed all the way to the left to connect with the neighboring terminal base/adaptor.
You cannot install the module unless the connector is fully extended.
3. Make sure the pins on the bottom of the module are straight so they will align properly with the connector in the terminal base.
4. Position the module (7) with its alignment bar (6) aligned with the groove (5) on the terminal base.
5. Press firmly and evenly to seat the module in the terminal base unit. The module is seated when the latching mechanism (2) is locked into the module.

Connect Wiring for 1794-OB8, 1794-OB8EP, 1794-OB16, and 1794-OB16P

1. Connect individual output wiring to numbered terminals on the 0-15 row (A) as indicated in the table below **1794-OB8** – Terminals 0...7; **1794-OB16 and 1794-OB16P** – terminals 0...15; **1794-OB8EP** – even numbered terminals 0...14.
2. Connect the associated -V output common to the corresponding terminal on the 16...33 row (B) for each output as indicated in the table below. Commons are internally connected together.
1794-OB8EP – connect associated output common to odd-numbered terminals on row A or associated terminals on row (B).
3. Connect +V DC power to terminal 34 on the 34...51 row (C).
4. Connect -V DC common to terminal 16 on the 16...33 row (B).
5. If daisy chaining power to the next terminal base, connect a jumper from terminal 51 (+V DC) on this base unit to terminal 34 on the next base unit.
6. If continuing -V DC common to the next base unit, connect a jumper from terminal 33 (common) on this base unit to terminal 16 on the next base unit.

Wiring Connections for 1794-OB8, 1794-OB16, and 1794-OB16P

used with 1794-TB2, 1794-TB3, or 1794-TB3S Terminal Base Unit

Output ⁽¹⁾	Output Terminal	Common Terminal
Output 0	A-0	B-17
Output 1	A-1	B-18
Output 2	A-2	B-19
Output 3	A-3	B-20
Output 4	A-4	B-21
Output 5	A-5	B-22
Output 6	A-6	B-23
Output 7	A-7	B-24
Output 8	A-8	B-25
Output 9	A-9	B-26
Output 10	A-10	B-27
Output 11	A-11	B-28
Output 12	A-12	B-29
Output 13	A-13	B-30
Output 14	A-14	B-31
Output 15	A-15	B-32
+V DC	C-34...C-51 (C-34 and C-51 for 1794-TB2)	
Common	B-16...B-33	

⁽¹⁾ **1794-OB8** – Outputs 0...7; **1794-OB16 and 1794-OB16P** – Outputs 0...15

Wiring Connections for 1794-OB8EP

Output	1794-TB2, 1794-TB3, 1794-TB3S		1794-TBN	
	Output Terminal	Common Terminal ⁽¹⁾	Output Terminal	Common Terminal ⁽²⁾
Output 0	A-0	A-1/B-17	B-0	C-1
Output 1	A-2	A-3/B-18	B-2	C-3
Output 2	A-4	A-5/B-19	B-4	C-5
Output 3	A-6	A-7/B-20	B-6	C-7
Output 4	A-8	A-9/B-21	B-8	C-9
Output 5	A-10	A-11/B-22	B-10	C-11
Output 6	A-12	A-13/B-23	B-12	C-13
Output 7	A-14	A-15/B-24	B-14	C-15
+V DC	C-34...C-51 (C-34 and C-51 for 1794-TB2, 1794-TBN)			
Common	B-16...B-33 (B-16 and B-33 for 1794-TBN)			

(1) **1794-TB2, 1794-TB3, 1794-TB3S** – A-1, A-3, A-5, A-7, A-9, A-11, A-13, and A-15 are connected together inside the module to 24V DC common.

(2) **1794-TBN** – C-1, C-3, C-5, C-7, C-9, C-11, C-13, and C-15 are connected together inside the module to 24V DC common.

1794-TB2, 1794-TB3, and 1794-TB3S Terminal Base Wiring for 1794-OB8, 1794-OB8EP, 1794-OB16, and 1794-OB16P

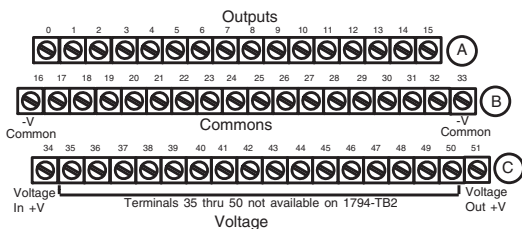

Connect -V (Supply Common) to terminal B-16 (1794-TB3 shown)

Connect +V (Supply +Voltage) to terminal C-34

(Use B-33 and C-51 for daisy-chaining to next terminal base unit.)

Total current draw through the terminal base is limited to 10A. Separate power connections to each terminal base may be necessary.

1794-TBN Terminal Base Wiring for 1794-OB8EP

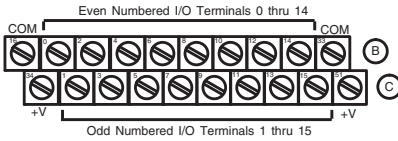

Connect -V (Supply Common) to terminal B-16

Connect +V (Supply +Voltage) to terminal C-34

(Use B-33 and C-51 for daisy-chaining to next terminal base unit.)

Total current draw through the terminal base is limited to 10A. Separate power connections to each terminal base may be necessary.

Connect Wiring for the 1794-OB32P

1. Connect individual output wiring (OUT0...OUT15) to numbered terminals on the 0...15 row (A) as indicated in the [Wiring Connections for 1794-OB32P](#) table.
2. Connect the associated power to the +V1 terminal (35, 37, 39, or 41) on the 34...51 row (C) as indicated in the [Wiring Connections for 1794-OB32P](#) table.
3. Connect the associated output common (-V1) for OUT0 to OUT15 to COM1 (terminal 36, 38, 40, or 42) on the 34...51 row (C).
4. Connect individual output wiring (OUT16...OUT31) to numbered terminals on the 16...33 row (B) as indicated in the [Wiring Connections for 1794-OB32P](#) table.
5. Connect the associated power to the +V2 terminal (43, 45, 47, or 49) on the 34...51 row (C) as indicated in the [Wiring Connections for 1794-OB32P](#) table.
6. Connect the associated output common (-V2) for OUT16...OUT31 to COM2 (terminals 44, 46, 48, or 50) on the 34...51 row (C).
7. If continuing power to the next terminal base, connect a jumper from terminal 35, 37, 39, or 41 (+V1) and 43, 45, 37, or 49 (+V2) on this base unit to the power terminal on the next base unit.
8. If continuing output common return to the next base unit, connect a jumper from terminal 36, 38, 40 or 42 (COM1) and 44, 46, 48 or 50 (COM2) on this base unit to common on the next base unit. Refer to the installation instructions for the next type of terminal base unit.

12 FLEX I/O Digital DC Output Modules

IMPORTANT Total current draw through terminal base connection is limited to 10 A. Separate power connections to each terminal base may be necessary.

Wiring Connections for 1794-OB32P

used with 1794-TB32 or 1794-TB32S Terminal Base Unit

Output	Output Terminal	Common	Power
Output 0	A-0	Connect common to terminals 36, 38, 40, and 42	Connect power to terminals 35, 37, 39, and 41
Output 1	A-1		
Output 2	A-2		
Output 3	A-3		
Output 4	A-4		
Output 5	A-5		
Output 6	A-6		
Output 7	A-7		
Output 8	A-8		
Output 9	A-9		
Output 10	A-10		
Output 11	A-11		
Output 12	A-12		
Output 13	A-13		
Output 14	A-14		
Output 15	A-15		
Output 16	B-17	Connect common to terminals 44, 46, 48, and 50	Connect power to terminals 43, 45, 47, and 49
Output 17	B-18		
Output 18	B-19		
Output 19	B-20		
Output 20	B-21		
Output 21	B-22		
Output 22	B-23		
Output 23	B-24		
Output 24	B-25		
Output 25	B-26		
Output 26	B-27		
Output 27	B-28		

Wiring Connections for 1794-OB32P

used with 1794-TB32 or 1794-TB32S Terminal Base Unit

Output	Output Terminal	Common	Power
Output 28	B-29	Connect common to terminals 44, 46, 48, and 50	Connect power to terminals 43, 45, 47, and 49
Output 29	B-30		
Output 30	B-31		
Output 31	B-32		

For Outputs 0...15, use +V1 and COM1

+V1 DC power	Power terminals 35, 37, 39, and 41
Com1 DC Return	Common terminals 36, 38, 40, and 42

For Outputs 16...31, use +V2 and COM2

+V2 DC power	Power terminals 43, 45, 47, and 49
Com2 DC Return	Common terminals 44, 46, 48, and 50

1794-TB32 and 1794-TB32S Terminal Base Wiring for 1794-OB32PI

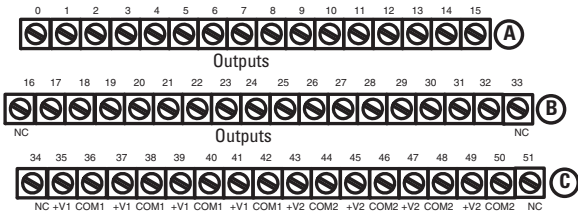

+V1 = Terminals 35, 37, 39 and 41

(1794-TB32 shown)

+V2 = Terminals 43, 45, 47 and 49

COM1 = Terminals 36, 38, 40 and 42

COM2 = Terminals 44, 46, 48 and 50

NC = No connections (terminals 16, 33, 34 and 51)

Configuring your 1794-OB8EP Output Module

Configure your output module by setting bits in the configuration word

Image Table Memory Map for the 1794-OB8EP Module

Dec	15	14	13	12	11	10	9	8	7	6	5	4	3	2	1	0
Oct	17	16	15	14	13	12	11	10	7	6	5	4	3	2	1	0
Read	F7	F6	F5	F4	F3	F2	F1	F0	Reserved ⁽¹⁾							
Write	Not used							FR	07	06	05	04	03	02	01	00

Where: 0 = Output – 00 corresponds to output 0, 01 corresponds to output 1, and so on.
 F = Overload fault bit – 1 = fault present; 0 = no fault
 FR = Fault reset bit – 1 = reset output; 0 = no change

⁽¹⁾ The unused lower byte in read word 1 floats during operation. Do not use this byte for fault status. See [Program the 1794-OB8EP](#).

Program the 1794-OB8EP

If your program automatically checks for fault bits, bits 8...15 of read word 1 must be masked. This is a sample program for a module at rack address 1, group 0. Add similar rungs to your program.

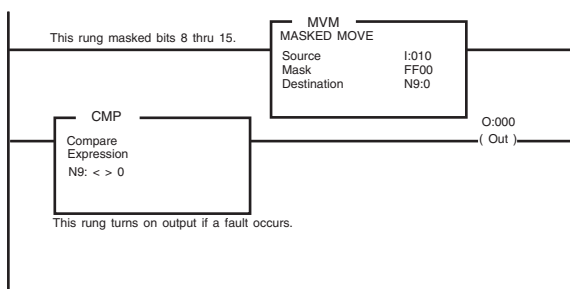

Reset a Fault on the 1794-OB8EP – Faults can be reset 3 ways: Press the fault reset button on the front of the module; or toggle the output reset bit (write word 1, bit 08); or cycle backplane power.

Use the Reset Button on the 1794-OB8EP – When you press the reset button, the fault indicator for the faulted output turns off for about 1.2 s. After the delay, the faulted output attempts to turn on. If the external condition causing the fault is corrected, the output will remain on, the fault indicator is off, and the status indicator is on.

Configure the 1794-OB8, 1794-OB16, 1794-OB16P, 1794-OB32P Modules

Configure your output module by setting bits in the configuration word (Word 3).

Image Table Memory Map – 1794-OB8, 1794-OB16, 1794-OB16P, and 1794-OB32 Modules

Dec	15	14	13	12	11	10	9	8	7	6	5	4	3	2	1	0
Oct	17	16	15	14	13	12	11	10	7	6	5	4	3	2	1	0
Read	Not used															
Write	015	014	013	012	011	010	09	08	07	06	05	04	03	02	01	00
Write 1794-OB32P only	031	030	029	028	027	026	025	024	023	022	021	020	019	018	017	016

Where: 0 = Output – 00 corresponds to output 0, 01 corresponds to output 1, and so on.
1794-OB8 uses outputs 0...7; **1794-OB16** and **1794-OB16P** use outputs 0...15; **1794-OB32P** uses outputs 0...31.

Specifications

Specifications – 1794-OB8

Attribute	Value
Number of outputs	8, current, sourcing
Recommended terminal base unit	1794-TB2, 1794-TB3, 1794-TB3S, 1794-TB3K, 1794-TB3SK
On-state voltage, output min	10V DC
On-state voltage, output nom	24V DC
On-state voltage, output max	31.2V DC
Output current rating	4 A (8 outputs @ 0.5 A)
On-state current, output, min	1.0 mA per channel
On-state current, output, max	500 mA per channel
On-state voltage drop, max	0.5V DC
Surge current	2 A for 50 ms, repeatable every 2 seconds
Off-state leakage current, max	0.5 mA
Isolation voltage	50V (continuous), Basic Insulation Type Tested at 850V DC for 1 s, between user and system No isolation between individual channels
Output signal delay ⁽¹⁾ Off to On On to Off	0.5 ms 1.0 ms
FlexBus current	60 mA @ 5V DC
Power dissipation, max	3.3 W @ 31.2V DC
Thermal dissipation, max	11.2 BTU/hr @ 31.2V DC
Fusing	Module outputs are not fused. Fusing is recommended. If fusing is desired, you must provide external fusing. Use SAN-O MQ4-800mA fuses.

⁽¹⁾ Delay time is the time from the receipt of an output on or off command to the output actually turning on or off.

Specifications – 1794-OB8EP

Attribute	Value
Number of outputs	8, current, sourcing
Recommended terminal base unit	1794-TB2, 1794-TB3, 1794-TB3S, 1794-TBN, 1794-TB3K, 1794-TB3SK, 1794-TBNK
On-state voltage, output min	19.2V DC

Specifications – 1794-OB8EP

Attribute	Value
On-state voltage, output nom	24V DC
On-state voltage, output max	31.2V DC
Output current rating	2.0 A max per output 10.0 A max per module (8 outputs @ 1.25 A, 5 outputs @ 2.0 A, or similar combinations totaling 10.0 A or less)
On-state current, output, min	1.0 mA per channel
On-state current, output, max	2.0 A per channel
On-state voltage drop, max	0.2V DC
Surge current	4 A for 50 ms, repeatable every 3 seconds
Off-state leakage current, max	0.5 mA
Isolation voltage	50V (continuous), Basic Insulation Type Tested at 850V DC for 1 s, between field side and system No isolation between individual channels
Output signal delay ⁽¹⁾ Off to On On to Off	0.1 ms 0.1 ms
FlexBus current	73 mA @ 5V DC
Power dissipation, max	5.5 W @ 31.2V DC
Thermal dissipation, max	18.8 BTU/hr @ 31.2V DC
Fusing	Outputs are electronically fused

⁽¹⁾ Delay time is the time from the receipt of an output on or off command to the output actually turning on or off.

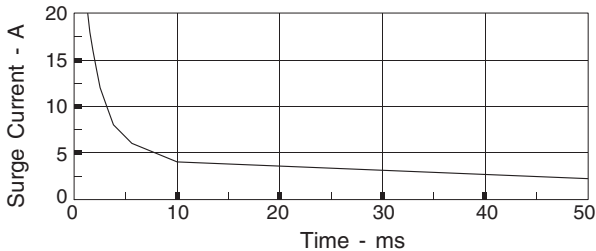
Surge Current for 1794-OB8EP**Output minimum Surge Current**

Specifications – 1794-OB16 and 1794-OB16P

Attribute	1794-OB16	1794-OB16P
Number of outputs	16, current, sourcing	
Recommended terminal base unit	1794-TB2, 1794-TB3, 1794-TB3S, 1794-TB3K, 1794-TB3SK	
On-state voltage, output min	10V DC	
On-state voltage, output nom	24V DC	
On-state voltage, output max	31.2V DC (see Derating Curve for 1794-OB16P)	
Output current rating	8.0 A (16 outputs @ 0.5 A)	
On-state current, output, min	1.0 mA per channel	
On-state current, output, max	500 mA per channel	
On-state voltage drop, max	0.5V DC	
Surge current	2 A for 50 ms, repeatable every 2 seconds	1.5 A for 50 ms, repeatable every 2 seconds
Off-state leakage current, max	0.5 mA	
Isolation voltage	50V (continuous), Basic Insulation Type Tested at 850V DC for 1 s between user and system No isolation between individual channels	50V (continuous), Basic Insulation Type Type tested at 2121V DC for 60 s, between field side and system No isolation between individual channels
Output signal delay ⁽¹⁾ Off to On On to Off	0.5 ms 1.0 ms	
FlexBus current	80 mA @ 5V DC	60 mA @ 5V DC
Power dissipation, max	5.3 W @ 31.2V DC	5.0 W @ 31.2V DC
Thermal dissipation, max	18.1 BTU/hr @ 31.2V DC	17.0 BTU/hr @ 31.2V DC
Fusing	Module outputs are not fused. Fusing is recommended. If fusing is desired, you must provide external fusing. Use SAN-O MQ4-800 mA fuses.	Outputs are electronically protected.

⁽¹⁾ Delay time is the time from the receipt of an output on or off command to the output actually turning on or off.

Specifications – 1794-OB32P

Attribute	Value
Number of outputs	32, current, sourcing
Recommended terminal base unit	1794-TB32, 1794-TB32S
On-state voltage, output min	10V DC
On-state voltage, output nom	24V DC
On-state voltage, output max	31.2V DC
Output current rating	14.0 A max per module (6 A total for channels 0...15; 8 A total for channels 16...31)
On-state current, min	1.0 mA per channel
On-state current, max	500 mA per channel
On-state voltage drop, max	0.5V DC
Surge current	2 A for 50 ms, repeatable every 2 seconds
Off-state leakage current, max	0.5 mA
Isolation voltage	50V (continuous), Basic Insulation Type Type tested at 850V DC for 60 s, between field side and system No isolation between individual channels
Output signal delay ⁽¹⁾ Off to On On to Off	0.5 ms 1.0 ms
FlexBus current	80 mA @ 5V DC
Power dissipation, max	5.3 W @ 31.2V DC
Thermal dissipation, max	18.1 BTU/hr @ 31.2V DC
Fusing	Outputs are electronically protected.

⁽¹⁾ Delay time is the time from the receipt of an output on or off command to the output actually turning on or off.

General Specifications

Attribute	Value
Off-state voltage, max	31.2V DC
Terminal base screw torque	Determined by installed terminal base
Dimensions, approx. (H x W x D)	94 x 94 x 69 mm (3.7 x 3.7 x 2.7 in.)

General Specifications

Attribute	Value
Weight, approx.	73 g (2.57 oz.) – 1794-OB8 104 g (3.66 oz.) – 1794-OB8EP 78 g (2.75 oz.) – 1794-OB16 74 g (2.61 oz.) – 1794-OB16P 85 g (2.99 oz.) – 1794-OB32P
Indicators (field side indication)	8 yellow status indicators – 1794-OB8, 1794-OB8EP 8 red fault indicators – 1794-OB8EP 16 yellow status indicators – 1794-OB16, 1794-OB16P 32 yellow status indicators – 1794-OB32P
External DC power supply voltage, nom	24V DC
External DC power voltage range	(1794-OB8, 1794-OB16, 1794-OB16P, 1794-OB32P) 10...31.2V DC (includes 5% AC ripple) (1794-OB8EP) 19.2...31.2V DC (includes 5% AC ripple)
External DC power supply current	25 mA @ 24V DC (10...35 mA) – 1794-OB8 80 mA @ 24V DC – 1794-OB8EP 49 mA @ 24V DC (20...65 mA) – 1794-OB16 60 mA @ 24V DC (25...75 mA) – 1794-OB16P (see Derating Curve) 219 mA @ 24V DC (104 mA @ 10V DC; 278 mA @ 31.2V DC) – 1794-OB32P
North American temp code	T4A – 1794-OB8, 1794-OB8EP, 1794-OB16 T3C – 1794-OB16P, 1794-OB32P
IEC temp code	T4 – 1794-OB8, 1794-OB8EP, 1794-OB16 T3 – 1794-OB16P
Keyswitch position	2
Enclosure type rating	None (open-style)
Wire size	Determined by installed terminal base
Wiring category ⁽¹⁾	2 - on signal ports

⁽¹⁾ Use this Conductor Category information for planning conductor routing. Refer to Industrial Automation Wiring and Grounding Guidelines, publication [1770-4.1](#).

Environmental Specifications

Attribute	Value
Operating temperature	IEC 60068-2-1 (Test Ad, Operating Cold), IEC 60068-2-2 (Test Bd, Operating Dry Heat), IEC 60068-2-14 (Test Nb, Operating Thermal Shock): -20...55 °C (-4...131 °F) – 1794-OB8, 1794-OB8EP, 1794-OB16, 1794-OB16P 0...55 °C (32...131 °F) – 1794-OB32P
Temperature, surrounding air, max	55 °C (131 °F)
Temperature, nonoperating	IEC 60068-2-1 (Test Ab, Unpackaged Non-operating Cold), IEC 60068-2-2 (Test Bb, Unpackaged Non-operating Dry Heat), IEC 60068-2-14 (Test Na, Unpackaged Non-operating Thermal Shock): -40...85 °C (-40...185 °F)
Relative humidity	IEC 60068-2-30 (Test Db, Unpackaged Damp Heat): 5...95% non-condensing
Vibration	IEC60068-2-6 (Test Fc, Operating): 5 g @ 10...500 Hz
Shock, operating	IEC60068-2-27 (Test Ea, Unpackaged shock): 30 g
Shock, nonoperating	IEC60068-2-27 (Test Ea, Unpackaged shock): 50 g
Emissions	CISPR 11: Group 1, Class A (with appropriate enclosure)
ESD immunity	IEC 61000-4-2: 6 kV contact discharges 8 kV air discharges
Radiated RF immunity	IEC 61000-4-3: (1794-OB8, 1794-OB8EP, 1794-OB16, 1794-OB16P only) 10V/m with 1 kHz sine-wave 80% AM from 80...2000 MHz 10V/m with 200 Hz 50% Pulse 100% AM @ 900 MHz 10V/m with 200 Hz 50% Pulse 100% AM @ 1890 MHz 10V/m with 1 kHz sine-wave 80% AM from 2000...2700 MHz – 1794-OB8, 1794-OB16 3V/m with 1 kHz sine-wave 80% AM from 2000...2700 MHz – 1794-OB8EP, 1794-OB16P IEC 61000-4-3: (1794-OB32P) 10V/m with 1 kHz sine-wave 80% AM from 30...1000 MHz
EFT/B immunity	IEC 61000-4-4: ±2 kV @ 5 kHz on power ports – 1794-OB8, 1794-OB16, 1794-OB32P ±3 kV @ 5 kHz on power ports – 1794-OB8EP, 1794-OB16P ±2 kV @ 5 kHz on signal ports – 1794-OB8, 1794-OB16, 1794-OB32P ±3 kV @ 5 kHz on signal ports – 1794-OB8EP, 1794-OB16P
Surge transient immunity	IEC 61000-4-5: ±1 kV line-line(DM) and ±2 kV line-earth(CM) on signal ports
Conducted RF immunity	IEC 61000-4-6: 10V rms with 1 kHz sine-wave 80% AM from 150 kHz...80 MHz

Certifications

Certifications (when product is marked) ⁽¹⁾	Value
c-UL-us	UL Listed Industrial Control Equipment, certified for US and Canada. See UL File E65584. UL Listed for Class I, Division 2 Group A,B,C,D Hazardous Locations, certified for U.S. and Canada. See UL File E334470. – 1794-OB32P
CSA	1794-OB8, 1794-OB8EP, 1794-OB16, 1794-OB16P only CSA Certified Process Control Equipment. See CSA File LR54689C. CSA Certified Process Control Equipment for Class I, Division 2 Group A,B,C,D Hazardous Locations. See CSA File LR69960C.
CE	European Union 2004/108/EC EMC Directive, compliant with: EN 61326-1; Meas./Control/Lab., Industrial Requirements EN 61000-6-2; Industrial Immunity EN 61000-6-4; Industrial Emissions EN 61131-2; Programmable Controllers (Clause 8, Zone A & B)
Ex	1794-OB8, 1794-OB8EP, 1794-OB16, 1794-OB16P only European Union 2014/34/EU ATEX Directive, compliant with: EN 60079-0; General Requirements EN 60079-15; Potentially Explosive Atmospheres, Protection "n" LCIE 01ATEX6020X – 1794-OB8, 1794-OB16 DEMKO 14ATEX1342501X – 1794-OB8EP, 1794-OB16P II 3 G Ex nA IIC T4 Gc – 1794-OB8EP III 3 G Ex nA IIC T3 Gc – 1794-OB16P
TÜV	1794-OB8EP, 1794-OB16, 1794-OB16P only TÜV Certified for Functional Safety: up to and including SIL 2
KC	Korean Registration of Broadcasting and Communications Equipment, compliant with: Article 58-2 of Radio Waves Act, Clause 3
EAC	Russian Customs Union TR CU 020/2011 EMC Technical Regulation
RCM	Australian Radiocommunications Act, compliant with: AS/NZS CISPR 11; Industrial Emissions

⁽¹⁾ See the Product Certification link at www.ab.com for Declarations of Conformity, Certificates, and other certification details.

Derating Curve for 1794-OB16P

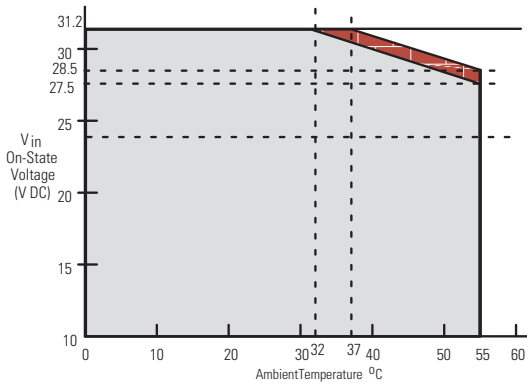

The area within the curve represents the safe operating range for the module under various conditions of user supplied 24V DC supply voltages and ambient temperatures.

- = Normal mounting safe operating range, (includes).
- = Other mounting positions (including inverted horizontal) safe operating

Normal Mounting – Horizontal

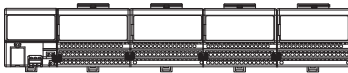

Other Mounting (including Vertical, and Inverted Horizontal Mounting)

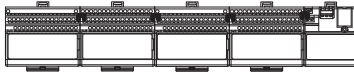

Rockwell Automation Support

Rockwell Automation provides technical information on the Web to assist you in using its products. At <http://www.rockwellautomation.com/support/>, you can find technical manuals, a knowledge base of FAQs, technical and application notes, sample code and links to software service packs, and a MySupport feature that you can customize to make the best use of these tools.

For an additional level of technical phone support for installation, configuration and troubleshooting, we offer TechConnect support programs. For more information, contact your local distributor or Rockwell Automation representative, or visit <http://www.rockwellautomation.com/support/>.

Installation Assistance

If you experience a problem within the first 24 hours of installation, please review the information that's contained in this manual. You can also contact a special Customer Support number for initial help in getting your product up and running.

United States or Canada	1.440.646.3434
Outside United States or Canada	Use the Worldwide Locator at http://www.rockwellautomation.com/support/americas/phone_en.html , or contact your local Rockwell Automation representative.

New Product Satisfaction Return

Rockwell Automation tests all of its products to ensure that they are fully operational when shipped from the manufacturing facility. However, if your product is not functioning and needs to be returned, follow these procedures.

United States	Contact your distributor. You must provide a Customer Support case number (call the phone number above to obtain one) to your distributor to complete the return process.
Outside United States	Please contact your local Rockwell Automation representative for the return procedure.

Documentation Feedback

Your comments will help us serve your documentation needs better. If you have any suggestions on how to improve this document, complete this form, publication [RA-DU002](#), available at <http://www.rockwellautomation.com/literature/>.

Allen-Bradley, Rockwell Automation, FLEX I/O, Rockwell Software, and TechConnect are trademarks of Rockwell Automation, Inc.

Trademarks not belonging to Rockwell Automation are property of their respective companies.

Rockwell Otomasyon Ticaret A.Ş., Kar Plaza İş Merkezi E Blok Kat:6 34752 İçerenköy, İstanbul, Tel: +90 (216) 5698400

www.rockwellautomation.com

Power, Control and Information Solutions Headquarters

Americas: Rockwell Automation, 1201 South Second Street, Milwaukee, WI 53204-2496 USA, Tel: (1) 414.382.2000, Fax: (1) 414.382.4444
Europe/Middle East/Africa: Rockwell Automation NV, Pegasus Park, De Kleeflaan 12a, 1831 Diegem, Belgium, Tel: (32) 2 663 0600, Fax: (32) 2 663 0640
Asia Pacific: Rockwell Automation, Level 14, Core F, Cyberport 3, 100 Cyberport Road, Hong Kong, Tel: (852) 2887 4788, Fax: (852) 2508 1846

Publication 1794-IN094D-EN-P - July 2018

Supersedes Publication 1794-IN094C-EN-P - July 2015

Copyright © 2018 Rockwell Automation, Inc. All rights reserved.