

D-D

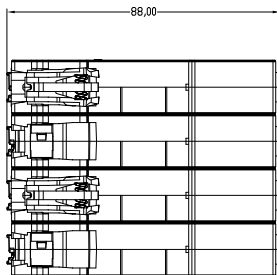

C-C

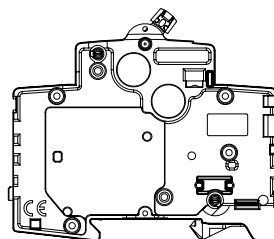
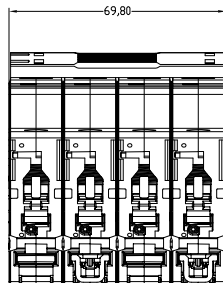
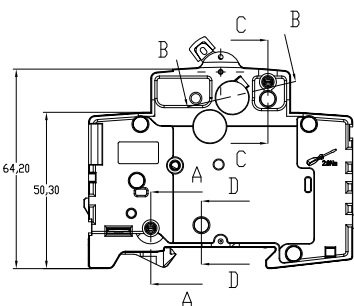
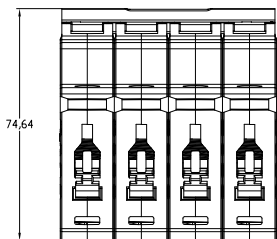

A-A

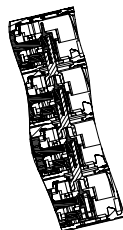
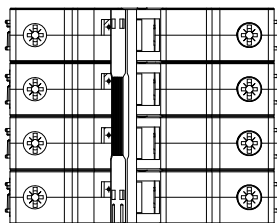

B-B

		C630-N	PN-D165622
		C500-N	PN-D165620
		C400-N	PN-D165618
		C320-N	PN-D165616
		C300-N	PN-D165614
		C250-N	PN-D165612
		C200-N	PN-D165610
		C160-N	PN-D165608
		C150-N	PN-D165606
		C130-N	PN-D165604
		C100-N	PN-D165602
		C080-N	PN-D165600
		C070-N	PN-D165598
		C060-N	PN-D165596
		C050-N	PN-D165594
		C040-N	PN-D165592
		C030-N	PN-D165590
		C020-N	PN-D165588
		C010-N	PN-D165586
		C005-N	PN-D165584
D630-N	PN-D165661	B630-N	PN-D165582
D500-N	PN-D165659	B500-N	PN-D165580
D400-N	PN-D165657	B400-N	PN-D165578
D320-N	PN-D165655	B320-N	PN-D165576
D300-N	PN-D167953	B300-N	PN-D165574
D250-N	PN-D165652	B250-N	PN-D165572
D200-N	PN-D165650	B200-N	PN-D165570
D160-N	PN-D165648	B160-N	PN-D165568
D150-N	PN-D165646	B150-N	PN-D165566
D130-N	PN-D165644	B130-N	PN-D165564
D100-N	PN-D165642	B100-N	PN-D165562
D080-N	PN-D165640	B080-N	PN-D165560
D070-N	PN-D165638	B070-N	PN-D165558
D060-N	PN-D165636	B060-N	PN-D165556
D050-N	PN-D165634	B050-N	PN-D165554
D040-N	PN-D165632	B040-N	PN-D165552
D030-N	PN-D165630	B030-N	PN-D165550
D020-N	PN-D165628	B020-N	PN-D165548
D010-N	PN-D165626	B010-N	PN-D165546
D005-N	PN-D165624	B005-N	PN-D167844
CATALOG NUMBER	MATERIAL MASTER	CATALOG NUMBER	MATERIAL MASTER

Rockwell Automation

CONFIDENTIAL AND PROPRIETARY INFORMATION. THIS DOCUMENT CONTAINS CONFIDENTIAL AND PROPRIETARY INFORMATION OF ROCKWELL AUTOMATION, INC. AND MAY NOT BE USED, COPIED OR DISCLOSED TO OTHERS EXCEPT WITH THE AUTHORIZED WRITTEN PERMISSION OF ROCKWELL AUTOMATION, INC.

SUPPLEMENTARY PROTECTOR, 3 POLE+N
1492-SPM3*

Sheet 1 OF 1

Drawn by: M. GUELEMI Date: 9/18/2013

Size	10000858764	Ver	00
c			