



POINT I/O 5V and 24V Encoder/Counter Modules

Catalog numbers 1734-IJ, 1734-IK, Series C

Table of Contents

Topic	Page
Important User Information	2
Environment and Enclosure	3
Preventing Electrostatic Discharge	3
North American Hazardous Location Approval	4
European Hazardous Location Approval	5
Additional Resources	6
Before You Begin	7
Install the Mounting Base	8
Install the Module	9
Install the Removable Terminal Block	10
Remove a Mounting Base	10
Wire the Module	11
Communicate with Your Module	13
Interpret Status Indicators	17
Specifications	19

Important User Information

Solid-state equipment has operational characteristics differing from those of electromechanical equipment. Safety Guidelines for the Application, Installation, and Maintenance of Solid-State Controls (Publication SGI-1.1 available from your local Rockwell Automation Sales Office or online at <http://www.rockwellautomation.com/literature/>) describes some important differences between solid-state equipment and hard-wired electromechanical devices. Because of this difference, and also because of the wide variety of uses for solid-state equipment, all persons responsible for applying this equipment must satisfy themselves that each intended application of this equipment is acceptable.





In no event will Rockwell Automation, Inc. be responsible or liable for indirect or consequential damages resulting from the use or application of this equipment.

The examples and diagrams in this manual are included solely for illustrative purposes. Because of the many variables and requirements associated with any particular installation, Rockwell Automation, Inc. cannot assume responsibility or liability for actual use based on the examples and diagrams.

No patent liability is assumed by Rockwell Automation, Inc. with respect to use of information, circuits, equipment, or software described in this manual.

Reproduction of the contents of this manual, in whole or in part, without written permission of Rockwell Automation, Inc., is prohibited.

Throughout this manual, when necessary, we use notes to make you aware of safety considerations.

	WARNING: Identifies information about practices or circumstances that can cause an explosion in a hazardous environment, which may lead to personal injury or death, property damage, or economic loss.
	ATTENTION: Identifies information about practices or circumstances that can lead to personal injury or death, property damage, or economic loss. Attentions help you identify a hazard, avoid a hazard, and recognize the consequences.
	SHOCK HAZARD: Labels may be on or inside the equipment (for example, drive or motor) to alert people that dangerous voltage may be present.
	BURN HAZARD: Labels may be on or inside the equipment (for example, drive or motor) to alert people that surfaces may reach dangerous temperatures.
IMPORTANT	Identifies information that is critical for successful application and understanding of the product.

Environment and Enclosure



ATTENTION: This equipment is intended for use in a Pollution Degree 2 industrial environment, in overvoltage Category II applications (as defined in IEC publication 60664-1), at altitudes up to 2000 m (6562 ft) without derating.

This equipment is considered Group 1, Class A industrial equipment according to IEC/CISPR Publication 11. Without appropriate precautions, there may be potential difficulties ensuring electromagnetic compatibility in other environments due to conducted as well as radiated disturbance.

This equipment is supplied as open-type equipment. It must be mounted within an enclosure that is suitably designed for those specific environmental conditions that will be present and appropriately designed to prevent personal injury resulting from accessibility to live parts. The enclosure must have suitable flame-retardant properties to prevent or minimize the spread of flame, complying with a flame spread rating of 5VA, V2, V1, V0 (or equivalent) if non-metallic. The interior of the enclosure must be accessible only by the use of a tool. Subsequent sections of this publication may contain additional information regarding specific enclosure type ratings that are required to comply with certain product safety certifications.

In addition to this publication, see:

- Industrial Automation Wiring and Grounding Guidelines, Rockwell Automation publication [1770-4.1](#), for additional installation requirements.
- NEMA Standard 250 and IEC 60529, as applicable, for explanations of the degrees of protection provided by different types of enclosure.



Preventing Electrostatic Discharge



ATTENTION: This equipment is sensitive to electrostatic discharge, which can cause internal damage and affect normal operation. Follow these guidelines when you handle this equipment:

- Touch a grounded object to discharge potential static.
 - Wear an approved grounding wriststrap.
 - Do not touch connectors or pins on component boards.
 - Do not touch circuit components inside the equipment.
 - Use a static-safe workstation, if available.
 - Store the equipment in appropriate static-safe packaging when not in use.
-

North American Hazardous Location Approval

<p>The following information applies when operating this equipment in hazardous locations:</p>	<p>Informations sur l'utilisation de cet équipement en environnements dangereux:</p>
<p>Products marked "CL I, DIV 2, GP A, B, C, D" are suitable for use in Class I Division 2 Groups A, B, C, D, Hazardous Locations and nonhazardous locations only. Each product is supplied with markings on the rating nameplate indicating the hazardous location temperature code. When combining products within a system, the most adverse temperature code (lowest "T" number) may be used to help determine the overall temperature code of the system. Combinations of equipment in your system are subject to investigation by the local Authority Having Jurisdiction at the time of installation.</p>	<p>Les produits marqués "CL I, DIV 2, GP A, B, C, D" ne conviennent qu'à une utilisation en environnements de Classe I Division 2 Groupes A, B, C, D dangereux et non dangereux. Chaque produit est livré avec des marquages sur sa plaque d'identification qui indiquent le code de température pour les environnements dangereux. Lorsque plusieurs produits sont combinés dans un système, le code de température le plus défavorable (code de température le plus faible) peut être utilisé pour déterminer le code de température global du système. Les combinaisons d'équipements dans le système sont sujettes à inspection par les autorités locales qualifiées au moment de l'installation.</p>
<div style="display: flex; align-items: center;">  <div> <p>EXPLOSION HAZARD</p> <ul style="list-style-type: none"> • Do not disconnect equipment unless power has been removed or the area is known to be nonhazardous. • Do not disconnect connections to this equipment unless power has been removed or the area is known to be nonhazardous. Secure any external connections that mate to this equipment by using screws, sliding latches, threaded connectors, or other means provided with this product. • Substitution of components may impair suitability for Class I, Division 2. • If this product contains batteries, they must only be changed in an area known to be nonhazardous. </div> </div>	<div style="display: flex; align-items: center;">  <div> <p>RISQUE D'EXPLOSION</p> <ul style="list-style-type: none"> • Couper le courant ou s'assurer que l'environnement est classé non dangereux avant de débrancher l'équipement. • Couper le courant ou s'assurer que l'environnement est classé non dangereux avant de débrancher les connecteurs. Fixer tous les connecteurs externes reliés à cet équipement à l'aide de vis, loquets coulissants, connecteurs filetés ou autres moyens fournis avec ce produit. • La substitution de composants peut rendre cet équipement inadapté à une utilisation en environnement de Classe I, Division 2. • S'assurer que l'environnement est classé non dangereux avant de changer les piles. </div> </div>

European Hazardous Location Approval

The following applies when the product bears the Ex Marking

This equipment is intended for use in potentially explosive atmospheres as defined by European Union Directive 94/9/EC.

DEMKO certifies that this equipment has been found to comply with the Essential Health and Safety Requirements relating to the design and construction of Category 3 equipment intended for use in Zone 2 potentially explosive atmospheres, given in Annex II to this Directive.

Compliance with the Essential Health and Safety Requirements has been assured by compliance with EN 60079-0:2012+A11:2013, EN 60079-15:2010, reference certificate number DEMKO 04ATEX0330347X.



ATTENTION: This equipment is not resistant to sunlight or other sources of UV radiation.



WARNING: This equipment shall be mounted in an ATEX certified enclosure with a minimum ingress protection rating of at least IP54 (as defined in IEC60529) and used in an environment of not more than Pollution Degree 2 (as defined in IEC 60664-1) when applied in Zone 2 environments. The enclosure must utilize a tool removable cover or door.

WARNING: This equipment shall be used within its specified ratings defined by Rockwell Automation.

WARNING: Provision shall be made to prevent the rated voltage from being exceeded by transient disturbances of more than 140% of the rated voltage when applied in Zone 2 environments.

WARNING: This equipment must be used only with ATEX certified Rockwell Automation backplanes.

WARNING: Secure any external connections that mate to this equipment by using screws, sliding latches, threaded connectors, or other means provided with this product.

WARNING: Do not disconnect equipment unless power has been removed or the area is known to be nonhazardous.

Additional Resources

See POINT I/O™ 5V and 24V Encoder/Counter Modules User Manual, publication [1734-UM006](#), as needed.

If you would like a manual, you can:

- download a free electronic version from the Internet:
<http://www.rockwellautomation.com/literature/>
- purchase a printed manual by contacting your local Allen-Bradley Distributor or Rockwell Automation representative.

Before You Begin

You can use these Series C POINT I/O Encoder/Counter modules with DeviceNet and PROFIBUS adapters. If you are using RSLogix 5000 software, version 11 or higher, you can also use the Series C modules with ControlNet and Ethernet adapters.

Use this diagram to identify the external features of the module.

POINT I/O 5V and 24V Encoder/Counter Modules

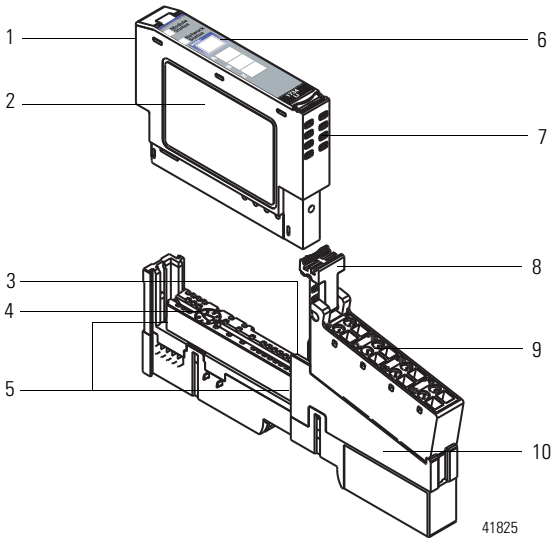

	Description		Description
1	Module locking mechanism	6	Slide-in writable label
2	Module wiring diagram	7	Insertable I/O module
3	DIN rail locking screw (orange)	8	Removable terminal block (RTB) handle
4	Mechanical keying (orange)	9	Removable terminal block
5	Interlocking side pieces	10	Mounting base

The wiring base assembly includes a terminal base, 1734-TB or 1734-TBS, which consists of a mounting base, 1734-MB, and removable terminal block, 1734-RT, or 1734-RTS.

Install the Mounting Base

To install the mounting base on the DIN rail, proceed as follows:



ATTENTION: This product is grounded through the DIN rail to chassis ground. Use zinc-plated, yellow-chromate steel DIN rail to assure proper grounding. The use of other DIN rail materials, for example, aluminum or plastic, that can corrode, oxidize, or are poor conductors, can result in improper or intermittent grounding.

Secure DIN rail to mounting surface approximately every 200 mm (7.8 in.) and use end-anchors appropriately.

1. Position the mounting base vertically above the installed units (adapter, power supply, or existing module).
 2. Slide the mounting base down allowing the interlocking side pieces to engage the adjacent module or adapter.
 3. Press firmly to seat the mounting base on the DIN rail. The mounting base snaps into place.
-



ATTENTION: Do not discard the end cap that is supplied with an adapter or communication interface module.

Use this end cap to cover the exposed interconnections on the last mounting base on the DIN rail. Failure to do so could result in equipment damage or injury from electric shock.

Install the Module



WARNING: When you insert or remove the module while backplane power is on, an electrical arc can occur. This could cause an explosion in hazardous location installations.

Be sure that power is removed or the area is nonhazardous before proceeding. Repeated electrical arcing causes excessive wear to contacts on both the module and its mating connector. Worn contacts may create electrical resistance that can affect module operation.

The module can be installed before or after base installation. Make sure that the mounting base is correctly keyed before installing the module into the mounting base. In addition, make sure that the mounting base locking screw is positioned horizontal referenced to the base.

1. Using a bladed screwdriver, rotate the keyswitch on the mounting base clockwise until the number required for the type of module being installed aligns with the notch in the base.
2. Verify that the DIN rail locking screw is in the horizontal position. You cannot insert the module if the locking mechanism is unlocked.
3. Insert the module straight down into the mounting base and press to secure. The module locks into place.

Install the Removable Terminal Block

A removable terminal block (RTB) is supplied with your wiring base assembly. To remove, pull up the RTB handle. This allows the mounting base to be removed and replaced as necessary without removing any of the wirings. To reinsert the removable terminal block, proceed as follows:

1. Insert the end opposite the handle into the base unit. This end has a curved section that engages with the wiring base.
2. Rotate the terminal block into the wiring base until it locks itself in place.
3. If an I/O module is installed, snap the RTB handle into place on the module.



WARNING: When you connect or disconnect the removable terminal block (RTB) with field-side power applied, an electrical arc can occur. This can cause an explosion in hazardous location installations.

Be sure that power is removed or the area is nonhazardous before proceeding

Remove a Mounting Base

To remove a mounting base, you must remove any installed module, and the module that is installed in the base to the right. Remove the removable terminal block, if wired.

1. Unlatch the RTB handle on the I/O module.
2. Pull on the RTB handle to remove the removable terminal block.
3. Press the module lock on the top of the module.
4. Pull on the I/O module to remove from the base.
5. Repeat steps 1, 2, 3 and 4 for the module to the right.
6. Use a small bladed screwdriver to rotate the orange base locking screw to a vertical position. This releases the locking mechanism.
7. Lift straight up to remove.

Wire the Module



WARNING: If you connect or disconnect wiring while the field-side power is on, an electrical arc can occur. This could cause an explosion in hazardous location installations. Be sure that power is removed or the area is nonhazardous before proceeding.

POINT I/O 5V and 24V Encoder/Counter Module

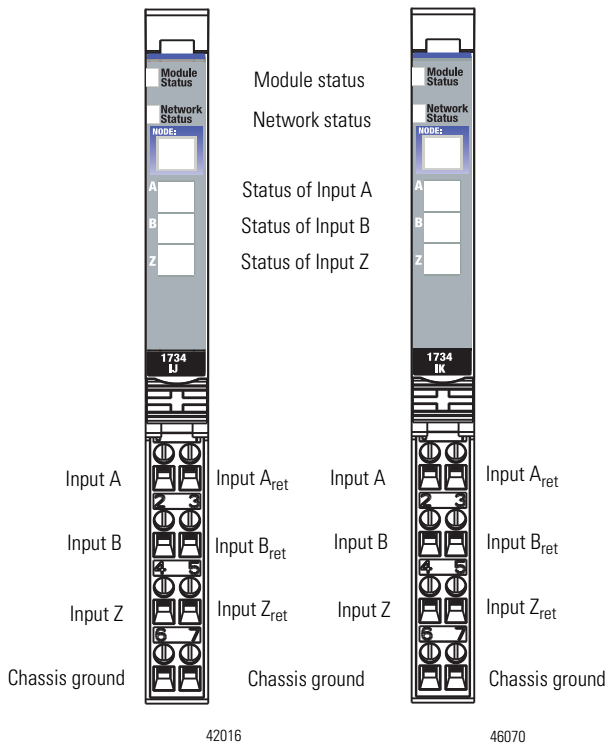

1734-IJ and 1734-IK Wiring Diagram

0 A	1 A _{ret}
2 B	3 B _{ret}
4 C	5 C _{ret}
6 Chas gnd	7 Chas gnd

A, B and Z, and A_{ret}, B_{ret}, and
Z_{ret} are inputs
Chas gnd = Chassis ground

Termination	Definition
0	A
1	A _{ret}
2	B
3	B _{ret}
4	Z
5	Z _{ret}
6	Chassis ground
7	Chassis ground

Communicate with Your Module

POINT I/O modules send (consume) and receive (produce) I/O messages. You map these messages into the processor's memory.

These modules produce 6 Bytes or 10 Bytes of input data (scanner Rx) (status). These modules consume 1 Byte of I/O data (scanner Tx). Use parameters 11 and 12 to select assembly 101, 102, or 103 for data that is produced by the modules.

Default Data Map for 1734-IJ, 1734-IK

Message size: 6 Bytes or 10 Bytes

	15	14	13	12	11	10	09	08	07	06	05	04	03	02	01	00
Produces (scanner Rx)	Channel 0 value of present counter state (LSW)															
	Channel 0 value of present counter state (MSW)															
	PE	EF	NR	0	0	0	0	0	0	ZS	BS	AS	C1	CO	ZD	0

Where:

- LSW = Least significant word
- MSW = Most significant word
- PE = Programming error
- EF = EEPROM fault status
- NR = Not ready status bit
- ZS = Z input status
- BS = B input status
- AS = A input status
- C1/CO = Stored data count
- ZD = Zero frequency detected

When you send a configuration to the module, check for consistency before applying it. Monitor the PE bit with your user program to isolate any problems with an improperly configured module. If the configuration is acceptable, the counter ASIC is disabled while the ASIC is loaded with new operational parameters. Outputs can turn off during this reconfiguration.

Message size: 1 Byte

	07	06	05	04	03	02	01	00
Consumes (scanner Tx)	0	0	0	0	0	VR	CP	CR

Where:

- VR = Value reset of stored/accumulated count
- CP = Counter preset
- CR = Counter reset

14 POINT I/O 5V and 24V Encoder/Counter Modules

Module Configuration

Parameter	Set/Get	Description	Bytes
1	Set/Get	Counter configuration	1
2	Set/Get	Filter selection	1
3	Set/Get	Decimal position	1
4	Set/Get	Reserved	1
5	Set/Get	Time base value	2
6	Set/Get	Gate interval	1
7	Set/Get	Channel scalar	1
8	Set/Get	Channel rollover value	4
9	Set/Get	Channel preset value	4
10	Set/Get	Counter control safe state	1
11	Set/Get	Requested poll produce assembly	1
12	Set/Get	Requested change of state produce assembly	1

Counter Configuration

07	06	05	04	03	02	01	00	
ZI	MD			CF				Counter 0
				0	0	0	0	Counter
				0	0	0	1	Encoder X1
				0	0	1	0	Encoder X2
				0	0	1	1	Not used
				0	1	0	0	Encoder X4
				0	1	0	1	Period/Rate
				0	1	1	0	Not used
				0	1	1	1	Rate measurement
	0	0	0					Store count disabled
	0	0	1					Mode 1 – store/continue
	0	1	0					Mode 2 – store/wait/resume
	0	1	1					Mode 3 – store, reset/wait/start
	1	0	0					Mode 4 – store, reset/start
	1	0	1					Reserved
	1	1	0					Reserved
	1	1	1					Reserved
0								Z input – 0 = not inverted
1								Z input – 1 = inverted

Filter Selection⁽¹⁾

07	06	05	04	03	02	01	00	
0	ZF	BF	AF	FS				
				0	0	0	0	No filter
				0	0	0	1	50 kHz (10 μ s + 0 μ s/-1.6 μ s)
				0	0	1	0	5 kHz (100 μ s + 0 μ s/-13.2 μ s)
				0	1	0	0	500 Hz (1 ms + 0 μ s/-125 μ s)
				1	0	0	0	50 Hz (10 ms + 0 ms/-1.25 ms)
			0					A input not filtered
			1					A input filtered
		0						B input not filtered
		1						B input filtered
	0							Z input not filtered
	1							Z input filtered

⁽¹⁾ Assumes a 50% duty cycle signal.

Scalar Selection

07	06	05	04	03	02	01	00	Scalar ⁽¹⁾
0	0	0	0	0	0	0	1	$Z - F_{\min} = 0.149$ Hz
0	0	0	0	0	0	1	0	$Z/2 - F_{\min} = 0.298$ Hz
0	0	0	0	0	1	0	0	$Z/4 - F_{\min} = 0.596$ Hz
0	0	0	0	1	0	0	0	$Z/8 - F_{\min} = 1.192$ Hz
0	0	0	1	0	0	0	0	$Z/16 - F_{\min} = 2.384$ Hz
0	0	1	0	0	0	0	0	$Z/32 - F_{\min} = 4.768$ Hz
0	1	0	0	0	0	0	0	$Z/64 - F_{\min} = 9.537$ Hz
1	0	0	0	0	0	0	0	$Z/128 - F_{\min} = 19.073$ Hz

⁽¹⁾ Where F_{\min} indicates the frequency at which the zero frequency detect is asserted due to counter overflow.

The Encoder/Counter Module uses several words to communicate real-time input and output data, and non-real time module information, that is, description, revision, and configuration. This shows the words that you can exchange. You can read (get) or write (set) data using an Explicit Message.

Assemblies

Instances (Dec/Hex)	Services	Field	Bytes
#101 (0x65)	Get	Present channel data	4
		Status	2
#102 (0x66)	Get	Stored channel data	4
		Status	2
#103 (0x67)	Get	Present channel data	4
		Stored channel data	4
		Status	2
#104 (0x68)	Get	Programming error code	2
#105 (0x69)	Set/Get	Counter control	1
#106 (0x6a)	Set/Get	Counter configuration	1
		Filter selection	1
		Decimal position	1
		Reserved	1
		Time base	2
		Gate interval	1
		Scalar	1
		Rollover value	4
		Preset value	4
		Counter control SSV	1
#123 (0x7b)	Set/Get	Counter configuration	1
		Filter selection	1
		Decimal position	1
		Reserved	1
		Time base	2
		Gate interval	1
		Scalar	1
		Rollover value	4
		Preset value	4
		Counter control SSV	1
Alignment (reserved = 0)	1		

Interpret Status Indicators

See the following diagram and table for information on how to interpret the status indicators.

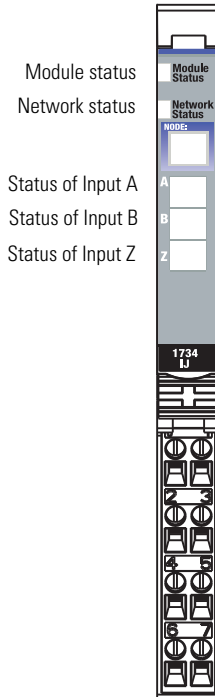

42016

Indicator Status for Modules

	Status	Description
Module status	Off	No power applied to device.
	Green	Device operating normally.
	Flashing green	Device needs commissioning due to missing, incomplete, or incorrect configuration.
	Flashing red	Recoverable fault.
	Red	Unrecoverable fault – may require device replacement.
	Flashing red/green	Device is in self-test mode.
Network status	Off	Device is not online: - Device has not completed dup_MAC-id test. - Device not powered – check module status indicator.
	Flashing green	Device is online but has no connections in the established state.
	Green	Device is online and has connections in the established state.
	Flashing red	One or more I/O connections are in timed-out state.
	Red	Critical link failure – failed communication device. Device detected error that prevents it from communicating on the network.
	Flashing red/green	Communication faulted device – the device has detected a network access error and is in communication faulted state. Device has received and accepted an Identity Communication Faulted Request – long protocol message.
Channel status	Off	Input is inactive.
	Yellow	Input is active and under control.
	Flashing yellow	1734-IJ only – Input is toggling on and off.

Specifications

POINT I/O 5V and 24V Encoder/Counter Module – 1734-IJ

Attribute	Value
Number of inputs	1 – 1 group of A/A return, B/B return and Z/Z return
Input voltage	5V
Input current	19.1 mA @ 5V DC 25.7 mA @ 6V DC
Input off-state current, max	≤ 0.250 mA
Input off-state voltage	≤ 1.25V DC
Input on-state current	≥ 5 mA
Input on-state voltage	≥ 2.6V DC
On-state voltage, max	± 6V
Input filter selections	Off 10 μs 100 μs 1.0 ms 10.0 ms
Input frequency, max	1.0 MHz counter and encoder X1 configurations 500 kHz encoder X2 configuration (no filter) 250 kHz encoder X4 configuration (no filter)

POINT I/O 5V and 24V Encoder/Counter Module – 1734-IK

Attribute	Value
Number of inputs	1 – 1 group of A/A return, B/B return and Z/Z return
Input voltage	15...24V DC
Input current	6.1 mA @ 15V DC 10.2 mA @ 24V DC
Input off-state current, max	≤ 0.250 mA
Input off-state voltage	≤ 1.8V DC
Input on-state current	≥ 5 mA
Input on-state voltage	≤ 12.5V DC

POINT I/O 5V and 24V Encoder/Counter Module – 1734-IK

Attribute	Value
On-state voltage, max	See the Input Derating Curve diagram.
Input filter selections	Off 10 μ s 100 μ s 1.0 ms 10.0 ms
Input frequency, max	1.0 MHz counter and encoder X1 configurations 500 kHz encoder X2 configuration (no filter) 250 kHz encoder X4 configuration (no filter)

General Specifications

Attribute	Value
Terminal base screw torque	0.6 Nm (7 lb-in.)
Module location	1734-TB, 1734-TBS, 1734-TB3, 1734-TB3S wiring base assembly
POINTBus current, max	160 mA
Power dissipation, max	1734-IJ – 1.1 W @ rated load 1734-IK – 1.5 W @ rated load
Thermal dissipation, max	1734-IJ – 3.75 BTU/hr @ rated load 1734-IK – 5.1 BTU/hr @ rated load
Isolation voltage (continuous-voltage withstand rating)	50V Type tested @ 1100V DC for 60 s, field-side to system
External DC power	No additional external power required to power module
Dimensions, approx., HxWxD	56.0 x 12.0 x 75.5 mm (2.21 x 0.47 x 2.97 in.)
Wiring category ⁽¹⁾	1 – on signal ports
Wire size	0.25...2.5 mm ² (22...14 AWG) solid or stranded copper wire rated at 75 °C (167 °F), or greater, 1.2 mm (3/64 in.) insulation max
Weight, approx.	0.36 kg (0.08 lb)
Keyswitch position	2
Enclosure type rating	None (open-style)
IEC temperature code	T4
North American temp code	T4A

⁽¹⁾ Use this conductor category information for planning conductor routing as described in Industrial Automation Wiring and Grounding Guidelines, publication [1770-4.1](#).

Environmental Specifications

Attribute	Value
Temperature, operating	IEC 60068-2-1 (Test Ad, Operating Cold), IEC 60068-2-2 (Test Bd, Operating Dry Heat), IEC 60068-2-14 (Test Nb, Operating Thermal Shock): -20...55 °C (-4...131 °F)
Temperature, storage	IEC 60068-2-1 (Test Ab, Unpackaged Nonoperating Cold), IEC 60068-2-2 (Test Bb, Unpackaged Nonoperating Dry Heat), IEC 60068-2-14 (Test Na, Unpackaged Nonoperating Thermal Shock): -40...85 °C (-40...185 °F)
Relative humidity	IEC 60068-2-30 (Test Db, Unpackaged Nonoperating Damp Heat): 5...95% noncondensing
Vibration	IEC60068-2-6 (Test Fc, Operating): 5 g @ 10...500 Hz
Shock, operating	EC 60068-2-27 (Test Ea, Unpackaged Shock): 30 g
Shock, nonoperating	EC 60068-2-27 (Test Ea, Unpackaged Shock): 50 g
Emissions	CISPR11 Group 1, Class A
ESD immunity	IEC6100-4-2: 6 kV contact discharges 8 kV air discharges
Radiated RF immunity	IEC 61000-4-3: 10V/m with 1 kHz sine-wave 80% AM @ 30...2000 MHz 10V/m with 200 Hz 50% pulse 100% AM @ 900 MHz
EFT/B immunity	IEC 61000-4-4: ±4 kV at 2.5 kHz on signal ports
Surge transient immunity	IEC 61000-4-5: ±1 kV line-line (DM) and ±2 kV line-earth (CM) on signal ports
Conducted RF immunity	IEC61000-4-6: 10V rms with 1 kHz sine-wave 80%AM @ 150 kHz...80 MHz

22 POINT I/O 5V and 24V Encoder/Counter Modules

Certifications

Certification (when product is marked) ⁽¹⁾	Value
c-UL-us	UL Listed Industrial Control Equipment, certified for U.S. and Canada. See UL File E65584. UL Listed for Class I, Division 2, Group A,B,C,D Hazardous Locations, certified for U.S. and Canada. See UL File E194810.
CE	European Union 89/336/EEC EMC Directive, compliant with: EN 50082-2; Industrial Immunity EN 61326; Meas./Control/Lab., Industrial Requirements EN 61000-6-2; Industrial Immunity EN 61000-6-4; Industrial Emissions EN 61131-2; Programmable Controllers (Cl. 8, Zone A & B)
C-Tick	Australian Radiocommunications Act, compliant with: AS/NZS CISPR11; Industrial Emissions
Ex	European Union 94/9/EC ATEX Directive, compliant with: EN 60079-0:2012 + A11:2013; General Requirements EN 60079-15:2010; Potentially Explosive Atmospheres, Protection "n" II 3 G Ex nA IIC T4 Gc DEMKO 04 ATEX 0330347X

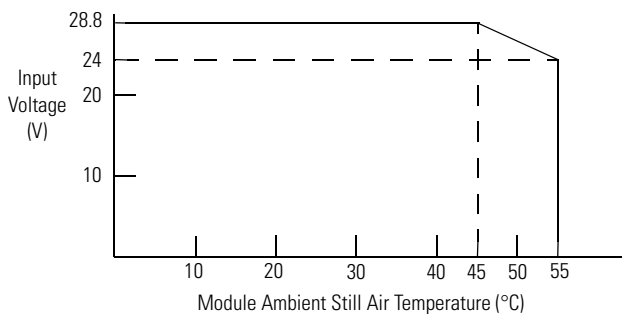

⁽¹⁾ See the Product Certification link at <http://www.rockwellautomation.com/products/certification/> for Declaration of Conformity, Certificates, and other certification details.

Input Derating Curve

ATTENTION: Exceeding the maximum input voltage can cause permanent damage to the input.

Rockwell Automation Support

Rockwell Automation provides technical information on the Web to assist you in using its products. At <http://www.rockwellautomation.com/support/>, you can find technical manuals, a knowledge base of FAQs, technical and application notes, sample code and links to software service packs, and a MySupport feature that you can customize to make the best use of these tools.

For an additional level of technical phone support for installation, configuration and troubleshooting, we offer TechConnect support programs. For more information, contact your local distributor or Rockwell Automation representative, or visit <http://www.rockwellautomation.com/support/>.

Installation Assistance

If you experience a problem within the first 24 hours of installation, please review the information that's contained in this manual. You can also contact a special Customer Support number for initial help in getting your product up and running.

United States or Canada	1.440.646.3434
Outside United States or Canada	Use the Worldwide Locator at http://www.rockwellautomation.com/support/americas/phone_en.html , or contact your local Rockwell Automation representative.

New Product Satisfaction Return

Rockwell Automation tests all of its products to ensure that they are fully operational when shipped from the manufacturing facility. However, if your product is not functioning and needs to be returned, follow these procedures.

United States	Contact your distributor. You must provide a Customer Support case number (call the phone number above to obtain one) to your distributor to complete the return process.
Outside United States	Please contact your local Rockwell Automation representative for the return procedure.

Documentation Feedback

Your comments will help us serve your documentation needs better. If you have any suggestions on how to improve this document, complete this form, publication [RA-DU002](#), available at <http://www.rockwellautomation.com/literature/>.

Allen-Bradley, Rockwell Automation, POINT I/O, and TechConnect are trademarks of Rockwell Automation, Inc.

Trademarks not belonging to Rockwell Automation are property of their respective companies.

Rockwell Otomasyon Ticaret A.Ş., Kar Plaza İş Merkezi E Blok Kat:6 34752 İçerenköy, İstanbul, Tel: +90 (216) 5698400

www.rockwellautomation.com

Power, Control and Information Solutions Headquarters

Americas: Rockwell Automation, 1201 South Second Street, Milwaukee, WI 53204-2496 USA, Tel: (1) 414.382.2000, Fax: (1) 414.382.4444
Europe/Middle East/Africa: Rockwell Automation, Vortlaan/Boulevard du Souverain 36, 1170 Brussels, Belgium, Tel: (32) 2 663 0600, Fax: (32) 2 663 0640
Asia Pacific: Rockwell Automation, Level 14, Core F, Cyberport 3, 100 Cyberport Road, Hong Kong, Tel: (852) 2887 4788, Fax: (852) 2508 1846

Publication 1734-IN005G-EN-E - June 2015

Supersedes Publication 1734-IN005F-EN-E - September 2012

Copyright © 2015 Rockwell Automation, Inc. All rights reserved.