

# 3M™ Surgical Drapes

*Drape Selection Guide*

orthopaedic • cardiovascular • OB/GYN • urology

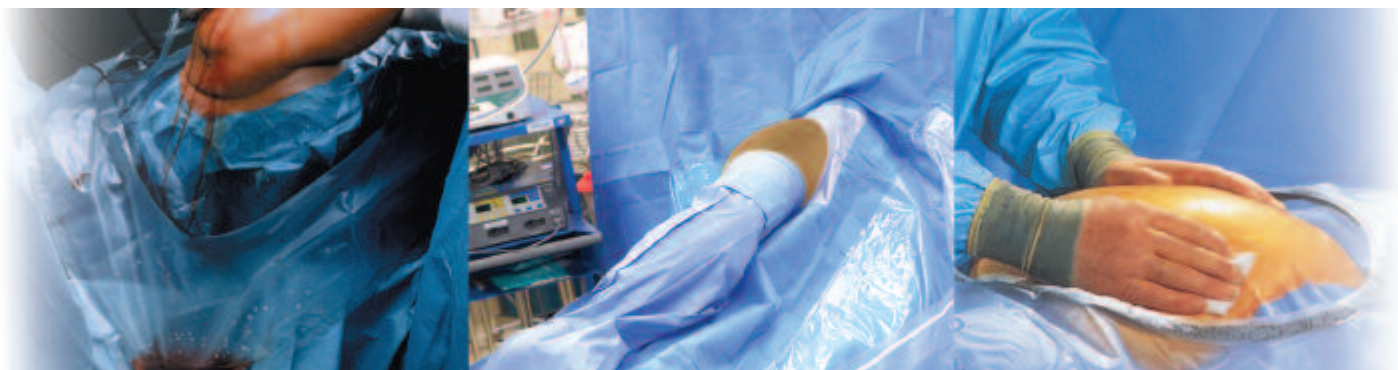

DRAPES THAT FIT ACCEPT NOTHING LESS

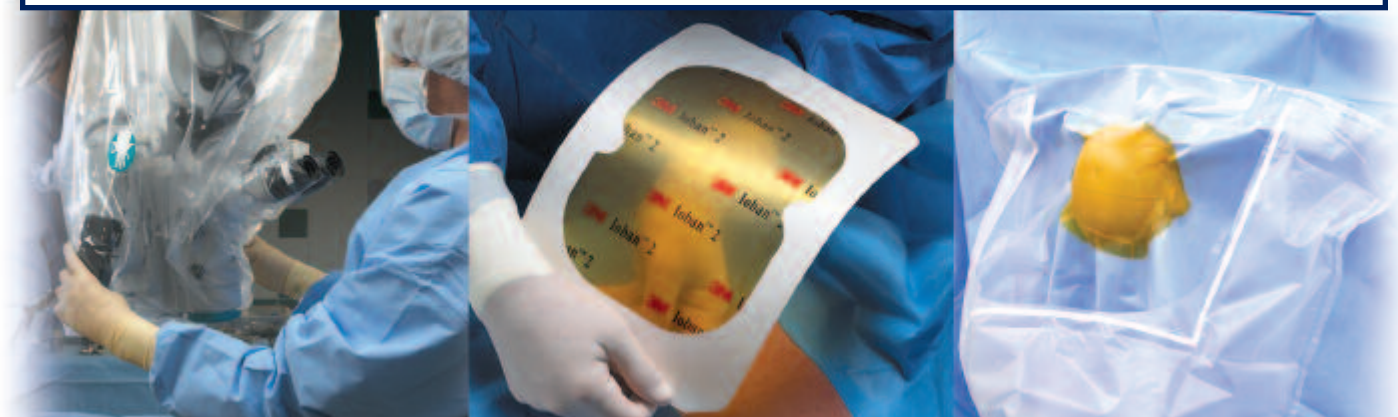

ophthalmic • EENT • neurology • general • equipment

# Setting 3M apart from the competition:

## 3M™ Steri-Drape™ Absorbent Prevention Fabric

- Low-linting, nonwoven, absorbent fabric laminated to a plastic film.
- Soaks up spills and splatters.
- No fluid strike-through.
- Absorbent throughout the entire drape, eliminates the need to define a “critical zone.”
- Meets Flammability Class 1 (CFR Title 16 Part 1610)

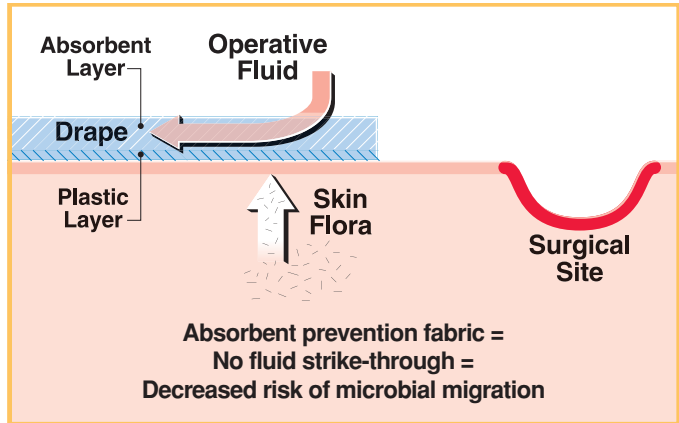

## 3M™ Ioban™ 2 Antimicrobial Incise Film

- Continuous broad-spectrum antimicrobial activity in the drape adhesive where it can't be washed away.
- Clinically proven to help reduce the risk of wound contamination and bacterial migration.
- Adheres better to skin than other incise drapes.

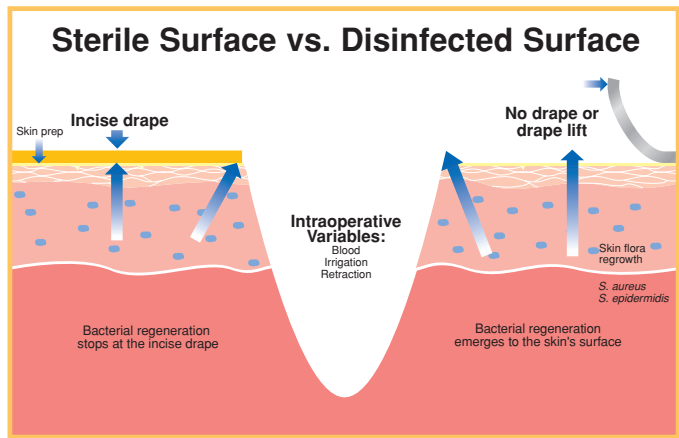

3M™ Incise Drapes create a sterile surface and act as a barrier to prevent skin flora from migrating to the incision.

## From the leader in medical films and adhesives

3M is a worldwide leader in film and adhesive technology. The medical films and adhesives featured in our drapes are some of the most dependable on the market today.

3M's expertise in adhesives, coatings, film and nonwoven technologies allows us to create a full line of drapes with the features most important to surgical teams. From our breathable, nonwoven “fabric” drapes to our antimicrobial incise drapes and everything in between, you'll find a 3M drape with the features you need to help create the sterile environment necessary for better patient outcomes.

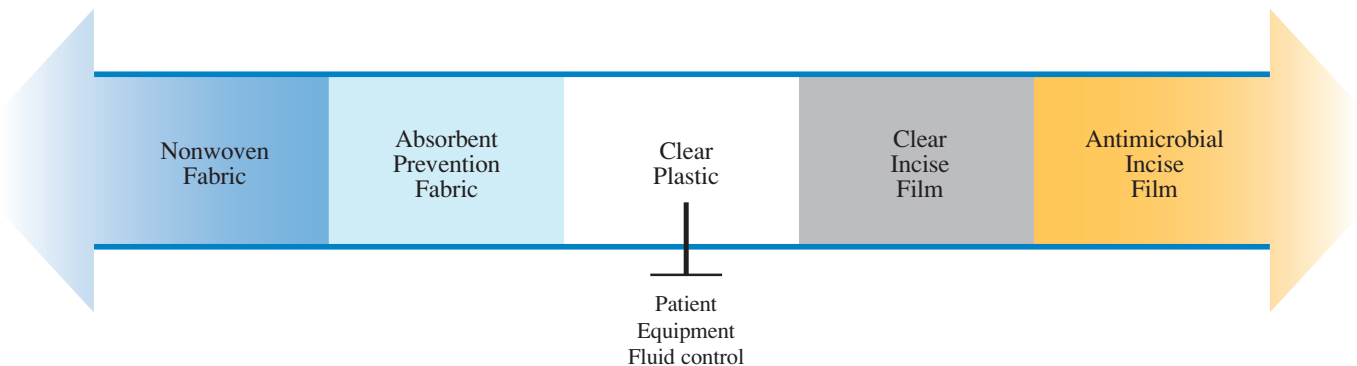

# DRAPE SELECTION GUIDE

	Page
Product Index by Catalog Number .....	iii-v
3M™ Ioban™ 2 Antimicrobial Incise and Specialty Fabric Drapes .....	2-5
3M™ Steri-Drape™ 2 Incise Drapes.....	6-7
3M™ Steri-Drape™ Orthopaedic Drapes .....	8-15
3M™ Steri-Drape™ Cardiovascular/Cardiac Catheterization Drapes.....	16-19
3M™ Steri-Drape™ Obstetrics and Gynaecology Drapes .....	20-25
3M™ Steri-Drape™ EENT Drapes.....	26-29
3M™ Steri-Drape™ General Surgery Drapes .....	30-37
3M™ Steri-Drape™ Urology Drapes.....	38-41
3M™ Steri-Drape™ Neurology Drapes .....	42-45
3M™ Steri-Drape™ Surgical Sheets and Accessories.....	46-53
3M™ Steri-Drape™ Fluid Collection Pouches .....	54-55
3M™ Steri-Drape™ Equipment Drapes.....	56-61

## INDEX BY CATALOG NUMBER

Page	Drape	Description
<b>1000 SERIES</b>		
49	1000Disp 1000NSR	Roll Prep Drape Roll Prep Drape
49	1000 1000NSD 1000NS	Small Towel Drape
36,52	1003 1003NS	Isolation Bag
15	1007	Arthroscopy Fluid Collection Pouch
59	1008	X-ray Cassette Drape
59	1009	X-ray Cassette Drape
49	1010 1010NSD 1010NS	Large Towel Drape
59	1011	Large X-ray Cassette Drape
58	1012 1012NS	Fluoroscope Drape
58	1013 1013NS	C-arm Drape
10	1014 1014NS	Patient Isolation Drape
14,44,46	1015 1015NSD 1015NS	U-drape
15,24,37, 41,44,54	1016 1016NS	Irrigation Pouch
11	1017	Isolation Drape with Incise Film and Pouch
52	1018 1018NS	Instrument Pouch
52	1018L 1018LNS	Long Instrument Pouch
14,44,46	1019 1019NS	Long U-drape
26,47	1020 1020NS	Small Drape with Adhesive Aperture
26,47	1021 1021NS	Small Drape with Incise Film
27	1022 1022NS	Refractive Drape
27	1023 1023NS	Small Drape with Incise Film and Pouch
27,54	1024 1024NS	Small Drape with Adhesive Aperture and Pouch
54	1027	Irrigation Pouch
28,47	1030 1030NS	Medium Drape with Adhesive Aperture
21,32,39	1031 1031NS	Laparoscopy Drape - Supine Position

Page	Drape	Description
21,32,39	1032 1032NS	Laparoscopy Drape - Lithotomy Position
28	1033 1033NS	Medium Drape with Wide Adhesive Aperture
7	1035 1035NS	Incise Drape
7	1040 1040NS	Incise Drape
7	1050 1050NS	Incise Drape
7	1051 1051NS	Incise Drape
29	1055B 1055NS	Large Ophthalmic Drape with Incise Film and Pouches
28	1060 1060NS	Medium Drape with Incise Film
28	1061 1061NS	Medium Drape with Incise Film and Pouch
29	1062 1062NS	Ophthalmic Drape with Incise Film and Pouch
29	1064 1064NS	Ophthalmic Drape with Aperture and Pouches
29	1065B 1065NS	Large Ophthalmic Drape with Aperture and Pouches
15,44,55	1067 1067NS	U-pouch
41	1071 1071NS	Urological Sheet
24,37,41, 54	1072 1072NS	Aperture Pouch Drape
36,52	1073	Wound Edge Protector
36,52	1074	Wound Edge Protector
36,52	1075	Wound Edge Protector
36,52	1076	Wound Edge Protector
21,40	1080 1080NS	Gynaecology Drape with Pouch
40	1081 1081NS	TUR/Urological Drape
18	1083 1083NS	Perineal/Leg Sheet
25,37,41, 54	1084 1084NS	Under Buttocks Drape with Pouch
51	1089 1089NS	Utility Sheet
17	1090 1090NS	Femoral Angiography Drape
48	1092 1092NS	Small Drape with Adhesive Aperture
13	1094 1094NS	Arthroscopy Drape with Pouch

Page	Drape	Description
8	1095 1095NS	Arthroscopy Pack
60	1096	Banded Bag
60	1097	Banded Bag
60	1098	Banded Bag
60	1099	Banded Bag
56	1100	Camera/Laser Drape
58	1101	One Piece C-arm Drape
53	1115	Tube Organiser
17	1191 1191NS	Femoral Angiography Drape
13	1194 1194NS	Arthroscopy Drape with Pouch
8	1195 1195NS	Arthroscopy Pack
<b>2000 SERIES</b>		
6	2035 2035NS	Incise Drape
6	2037 2037NS	Incise Drape
6	2040 2040NS	Incise Drape
6	2045 2045NS	Incise Drape
6	2050 2050NS	Incise Drape
6	2051 2051NS	Incise Drape
24,35,55	2057 2057NS	Incise Pouch
24,35,55	2058 2058NS	Aperture Pouch
21,32,39	2065 2065NS	Abdominal-Perineal Drape - Lithotomy Position
<b>4000 SERIES</b>		
56	4730	Video Camera/Laser Drape
56	4731	Closed System Video Camera Drape
58	4738	C-arm Drape
58	4739	Mini C-arm Drape
59	4741	X-ray Cassette Drape
59	4742	X-ray Cassette Drape with Liner
58	4750	Banded Fluoroscope Drape
60	4783	Slush Machine Drape
60	4784	Slush Machine Drape
56	4785	Microscope Drape for Zeiss® MD®
56	4786	Microscope Drape for Zeiss® MD®

Page	Drape	Description
56	4787	Microscope Drape for Zeiss® MD®
56	4788	Microscope Drape for Zeiss® OPMI®
57	4789	Microscope Drape for Zeiss® OPMI®
57	4790	Microscope Drape for Zeiss® OPMI®
57	4791	Microscope Drape for Leica®
57	4792	Microscope Drape for Leica® M680
57	4793	Microscope Drape for Leica® Space Pointer
57	4794	Microscope Drape for Leica®
<b>6600 SERIES</b>		
2,11	6617	Isolation Drape with loban 2 Incise Film and Pouch
2,11	6619	Large Isolation Drape with loban 2 Incise Film and Pouch
2	6635	Antimicrobial Incise Drape
2	6640EZ* 6640EZSB 6640**	Antimicrobial Incise Drape
2	6648EZ* 6648EZSB 6648**	Antimicrobial Incise Drape
3	6650EZ* 6650EZSB 6650**	Antimicrobial Incise Drape
3	6651EZ* 6651EZSB 6651**	Antimicrobial Incise Drape
3,24,35,55	6657	Pouch with loban 2 Incise Film
3,35,55	6658	Pouch with loban 2 Incise Film, Large
35,55	6659	Pouch with loban 2 Incise Film, Extra Large
3	6661EZ* 6661EZSB	Antimicrobial Incise Drape
4,22,32, 39	6665	loban 2 Abdominal-Perineal Drape - Lithotomy Position
4,18	6677	Cardiovascular Drape with loban 2 Incise Film
4,18	6678	Cardiovascular Pack
5,19	6681	Cardiovascular Drape with loban 2 Incise Film
5,43	6687	Craniotomy Drape
5,23	6697	Cesarean Section Drape with loban 2 Incise Pouch
<b>7000 SERIES</b>		
23	7965 7965NS	Cesarean Section Drape with Incise Pouch
23	7966 7966NS	Cesarean Section Drape with Adhesive Aperture Pouch

\*Denotes loban 2 drapes with easy-delivery features. Available in the U.S. and limited markets outside the U.S.

\*\*Available outside the U.S. only

## INDEX BY CATALOG NUMBER

Page	Drape	Description	Page	Drape	Description
<b>9000 SERIES</b>					
8,16,20, 30,38,42	9000A	Basic Surgical Pack	43,47	9048 9048NS	Adhesive Split Sheet
8,16,20, 30,38,42	9000LA	Basic Surgical Pack	33,48	9050 9050NS	Adhesive Aperture Drape
9	9002	Orthopaedic Pack without Mayo Stand Cover	34	9051 9051NS	Thyroid Drape
20,30,38	9003	Cystoscopy Pack	11,34	9052 9052NS	Hand Drape
26	9007A	EENT Pack	12	9053 9053NS	Extremity Drape
26	9008A	Head and Neck Pack	12,34	9054 9054NS	Hand and Foot Drape
9,16,20, 31,38,42	9010	Basic Surgical Pack without Mayo Stand Cover	13	9055 9055NS	Hip Drape
9	9012A	Orthopaedic Pack	12,34	9056 9056NS	Bilateral Foot Drape
10	9012LA	Orthopaedic Pack	22,33,40	9062 9062NS	Laparotomy Drape (transverse)
10	9014A	Extremity Pack	22,33,40	9063 9063NS	Laparotomy Drape
31,42	9018A	Surgical Split Sheet Pack	51	9069 9069NS	Drape Sheet
20,26,31, 38	9020A	Basic Set-up Pack	51	9072 9072NS	Drape Sheet/Back Table Cover
10	9021A	Orthopaedic Set-up Pack	51	9077 9077NS	Drape Sheet/Back Table Cover
17	9022A	Cardiovascular Set-up Pack	51	9079 9079NS	Drape Sheet/Back Table Cover
48	9026 9026NS	Aperture Drape	49	9084 9084NS	Adhesive Towel Drape
48	9029 9029NS	Adhesive Aperture Drape	49	9085 9085NS	Adhesive Towel Drape
48	9030 9030NS	Adhesive Aperture Drape	50	9086 9086NS	Adhesive Towel Drape
48	9031 9031NS	Adhesive Aperture Drape	50	9087 9087NS	Adhesive Drape Sheet
52	9036 9036NS	Mayo Stand Cover	50	9088 9088NS	Adhesive Drape Sheet
25,41,53	9040 9040NS	Leggings (pair)	50	9090 9090NS	Adhesive Drape Sheet
15,53	9041 9041NS	Extremity Cover	53	9095	Absorbent Pad
15,53	9042 9042NS	Extremity Cover	52	9097 9097NS	Instrument Pouch (L)
14,43,46	9043 9043NS	Adhesive Split Sheet	53	9099 9099NS	OP Tape
14,43,46	9044 9044NS	Adhesive Split Sheet	13	9196 9196NS	Shoulder Split Sheet with Pouch
14,43,46	9045 9045NS	Adhesive Split Sheet			
14,19,46	9046 9046NS	Bilateral Split Sheet			
43	9047 9047NS	Neuro Split Sheet with Pouch			

# 3M™ SURGICAL DRAPES

*A line of drapes designed with the six principles of draping in mind*

Whether a surgery is performed in a traditional operating room, an ambulatory surgery center or a physician's office, you can be sure of one thing: one or more surgical drapes will be used. And every drape used during that procedure will address one or more of the six basic draping objectives or "principles." 3M offers many single-use, disposable surgical drapes to meet these principles:



## 1. Isolation

Isolating dirty, contaminated areas from clean areas.



## 2. Barrier

Preventing fluid penetration.



## 3. Sterile Field

Creating a sterile operative environment by aseptic application of sterile materials.



## 4. Sterile Surface

Creating a sterile surface on the skin which acts as a barrier to prevent skin flora from migrating to the incision site.



## 5. Fluid Control

Channeling and collecting body and irrigation fluids.



## 6. Equipment Draping

Allowing non-sterile equipment to be brought into the sterile field.

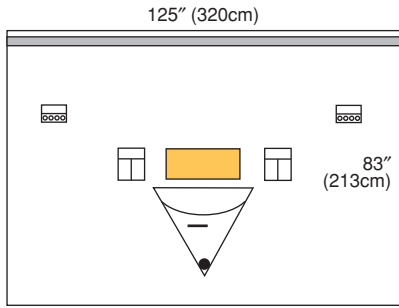

**6617 Isolation Drape with Ioban™ 2 Incise Film and Pouch**

Overall Size	Drapes/Box	Boxes/Case
125" x 83" (320cm x 213cm)	5	4
<ul style="list-style-type: none"> <li>• Ioban 2 antimicrobial incise area: 19" x 9 3/8" (50cm x 24cm)</li> <li>• Fluid collection pouch with screen</li> <li>• 1 – Exit port</li> <li>• 2 – Instrument pouches</li> <li>• 2 – Tube and cord organizers</li> <li>• Adhesive strip along top</li> </ul>		

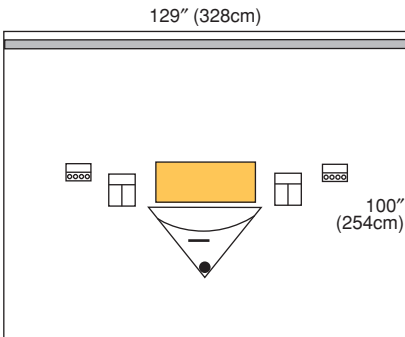

**6619 Large Isolation Drape with Ioban 2 Incise Film and Pouch**

Overall Size	Drapes/Box	Box/Case
129" x 100" (328cm x 254cm)	5	1
<ul style="list-style-type: none"> <li>• Ioban 2 antimicrobial incise area: 27" x 12" (70cm x 32cm)</li> <li>• Fluid collection pouch with screen</li> <li>• 1 – Exit port</li> <li>• 2 – Instrument pouches</li> <li>• 2 – Tube and cord organizers</li> </ul>		

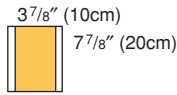

**6635 Ioban 2 Antimicrobial Incise Drape**

Incise Area	Drapes/Box	Boxes/Case
3 7/8" x 7 7/8" (10cm x 20cm)	10	4

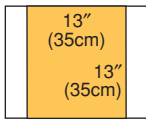

**6640EZ\* Ioban 2 Antimicrobial Incise Drape**

Incise Area	Drapes/Box	Boxes/Case
13" x 13" (35cm x 35cm)	10	4
<b>6640EZSB</b> (Sterile Bulk) <i>Custom Packs Only</i>	10 ea/cs	

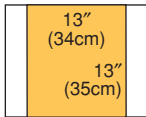

**6640\*\* Ioban 2 Antimicrobial Incise Drape**

Incise Area	Drapes/Box	Boxes/Case
13" x 13" (34cm x 35cm)	10	4

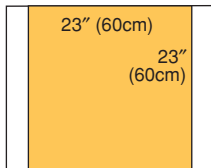

**6648EZ\* Ioban 2 Antimicrobial Incise Drape**

Incise Area	Drapes/Box	Boxes/Case
23" x 23" (60cm x 60cm)	10	4
<b>6648EZSB</b> (Sterile Bulk) <i>Custom Packs Only</i>	75 ea/cs	

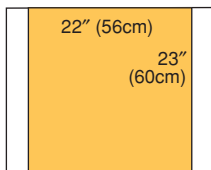

**6648\*\* Ioban 2 Antimicrobial Incise Drape**

Incise Area	Drapes/Box	Boxes/Case
22" x 23" (56cm x 60cm)	10	4

Incise Drapes

**KEY**

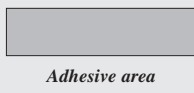
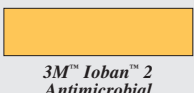
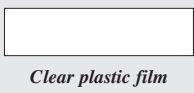
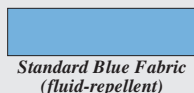
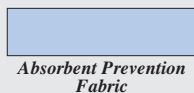



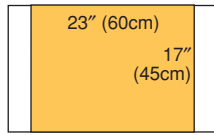

### 6650EZ\* Ioban 2 Antimicrobial Incise Drape

Incise Area	Drapes/Box	Boxes/Case
23" x 17" (60cm x 45cm)	10	4
<b>6650EZSB</b> (Sterile Bulk) <i>Custom Packs Only</i>	100 ea/cs	

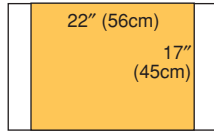

### 6650\*\* Ioban 2 Antimicrobial Incise Drape

Incise Area	Drapes/Box	Boxes/Case
22" x 17" (56cm x 45cm)	10	4

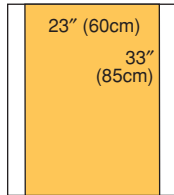

### 6651EZ\* Ioban 2 Antimicrobial Incise Drape

Incise Area	Drapes/Box	Boxes/Case
23" x 33" (60cm x 85cm)	10	4
<b>6651EZSB</b> (Sterile Bulk) <i>Custom Packs Only</i>	50 ea/cs	

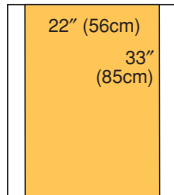

### 6651\*\* Ioban 2 Antimicrobial Incise Drape

Incise Area	Drapes/Box	Boxes/Case
22" x 33" (56cm x 85cm)	10	4

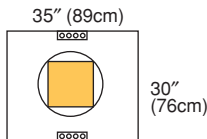

### 6657 Pouch with Ioban 2 Incise Film

Overall Size	Drapes/Box	Boxes/Case
35" x 30" (89cm x 76cm)	10	4
• Ioban 2 antimicrobial incise area: 12" x 12" (30cm x 30cm)		
• 360-degree fluid collection pouch		
• Tube and cord organizers		

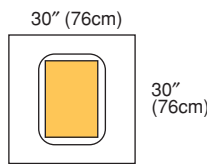

### 6658 Pouch with Ioban 2 Incise Film, Large

Overall Size	Drapes/Box	Boxes/Case
30" x 30" (76cm x 76cm)	5	4
• Ioban 2 antimicrobial incise area: 13" x 17" (33cm x 43cm)		
• 360-degree fluid collection pouch		

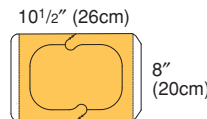

### 6661EZ\* Ioban 2 Antimicrobial Incise Drape

Incise Area	Drapes/Box	Boxes/Case
10 1/2" x 8" (26cm x 20cm)	50	4
<b>6661EZSB</b> (Sterile Bulk) <i>Custom Packs Only</i>	400ea/cs	

\*Denotes Ioban 2 drapes with easy-delivery features. Available in the U.S. and limited markets outside the U.S.

\*\*Available outside the U.S. only

### Easy-delivery (products denoted with EZ) features include:

- Polyethylene liner comes off smoothly, effortlessly, with no tearing, for easier drape delivery
- Drape and liner feature a full-width handle for control of liner release and drape application
- Strip at one end imprinted with stop signs indicates when the end of the drape is near

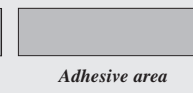
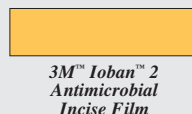
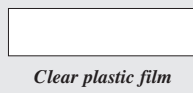
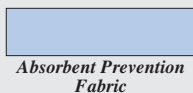

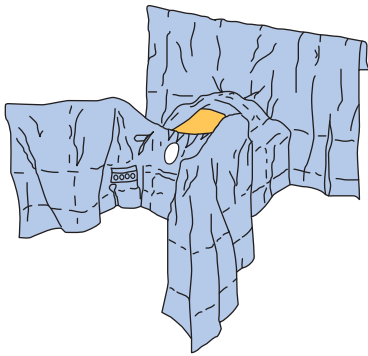

**6665 Ioban 2 Abdominal-Perineal Drape - Lithotomy Position**

Overall Size	Drapes/Box	Box/Case
78" x 106" (200cm x 270cm)	5	1
<ul style="list-style-type: none"> <li>Ioban 2 antimicrobial incise area: 13" x 18" (35cm x 46cm)</li> <li>Peri/vag. aperture: 4<sup>5</sup>/<sub>8</sub>" x 6" (12cm x 15,5cm)</li> <li>Tube and cord organizers (ref.1115)</li> <li>Absorbent Prevention Fabric</li> </ul>		

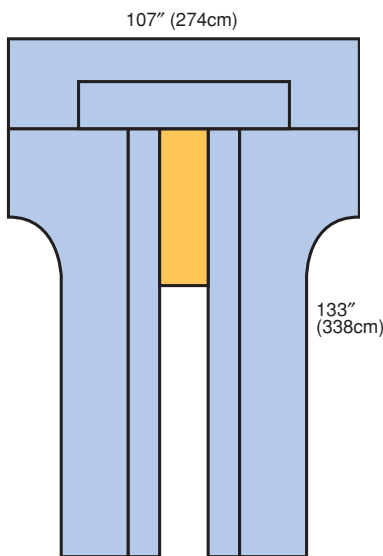

**6677 Cardiovascular Drape with Ioban 2 Incise Film**

Overall Size	Drapes/Box	Box/Case
107" x 133" (274cm x 338cm)	6	1
<ul style="list-style-type: none"> <li>Ioban 2 antimicrobial incise area: 16" x 36" (41cm x 92cm)</li> <li>Dual side pockets</li> <li>Reinforced anesthesia screen</li> <li>Absorbent Prevention Fabric</li> </ul>		

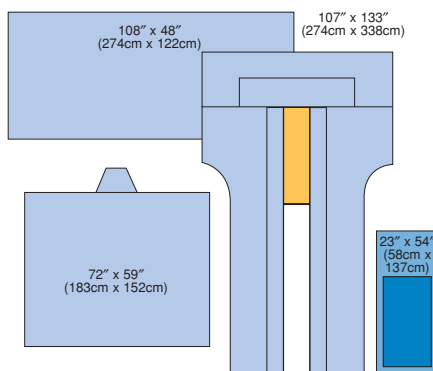

**6678 Cardiovascular Pack**

Name	Amount	Overall Size	Packs/Box	Boxes/Case
6677 Steri-Drape Cardiovascular Sheet with Ioban 2 Incise Film	1	107" x 133" (274cm x 338cm)	4	1
1083 Perineal/Leg Sheet	1	72" x 59" (183cm x 152cm)		
9036 Mayo Stand Cover	1	23" x 54" (58cm x 137cm)		
Back Table Cover	1	108" x 48" (274cm x 122cm)		

**KEY**

Absorbent Prevention Fabric	Standard Blue Fabric (fluid-repellent)	Clear plastic film	3M™ Ioban™ 2 Antimicrobial Incise Film	3M™ Steri-Drape™ 2 Incise Film	Adhesive area

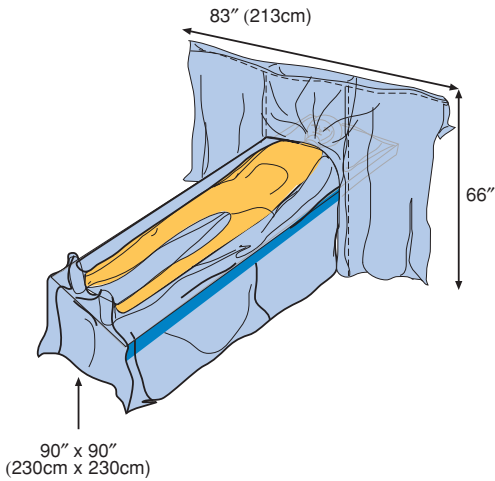

### 6681 Cardiovascular Drape with loban 2 Incise Film

Overall Size	Drapes/Box	Box/Case
90" x 90" (230cm x 230cm)	8	1
<ul style="list-style-type: none"> <li>• Width at arm extensions: 83" (213cm)</li> <li>• loban 2 antimicrobial incise area: 11" x 59" (30cm x 152cm)</li> <li>• One-piece design</li> <li>• Expansion pleat between legs</li> <li>• Blue anesthesia screen</li> <li>• loban 2 antimicrobial incise film in both chest and leg areas</li> <li>• Absorbent Prevention Fabric</li> </ul>		

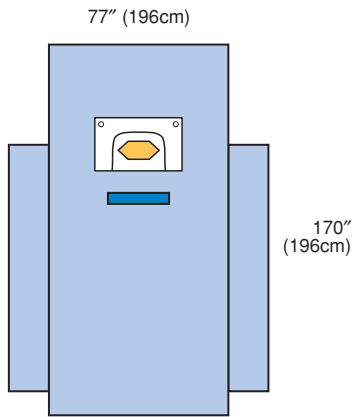

### 6687 Craniotomy Drape

Overall Size	Drapes/Box	Boxes/Case
77" x 170" (196cm x 432cm)	10	1
<ul style="list-style-type: none"> <li>• Incise area: 14.5" x 8.43" (36.8cm x 21.4cm)</li> <li>• Large rectangular fluid collection pouch</li> <li>• Reinforced plastic strip with a wide adhesive secural</li> <li>• Absorbent Prevention Fabric</li> </ul>		

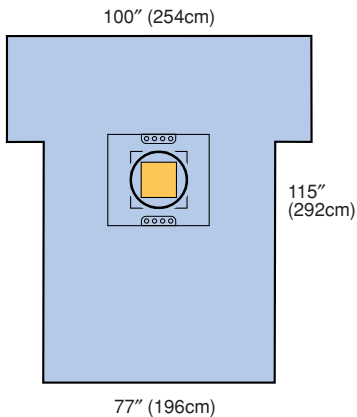

### 6697 Cesarean Section Drape with loban 2 Incise Pouch

Overall Size	Drapes/Box	Box/Case
77" x 115" (196cm x 292cm)	5	1
<ul style="list-style-type: none"> <li>• Width at arm extensions: 100" (254cm)</li> <li>• loban 2 antimicrobial incise area: 12" x 12" (30cm x 30cm)</li> <li>• 360-degree fluid collection pouch</li> <li>• Tube and cord organizers</li> </ul>		

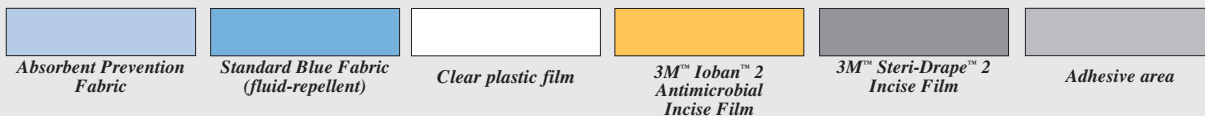

# 3M™ Steri-Drape™ 2 INCISE DRAPES

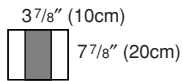

## 2035 Incise Drape

Incise Area	Drapes/Box	Boxes/Case
3 7/8" x 7 7/8" (10cm x 20cm)	10	4
<b>2035NS</b> (non-sterile) <i>Custom Packs Only</i>	200 ea/cs	

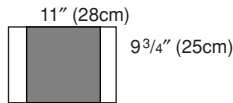

## 2037 Incise Drape

Incise Area	Drapes/Box	Boxes/Case
11" x 9 3/4" (28cm x 25cm)	10	4
<b>2037NS</b> (non-sterile) <i>Custom Packs Only</i>	200 ea/cs	

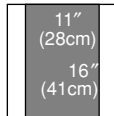

## 2040 Incise Drape

Incise Area	Drapes/Box	Boxes/Case
11" x 16" (28cm x 41cm)	10	4
<b>2040NS</b> (non-sterile) <i>Custom Packs Only</i>	200 ea/cs	

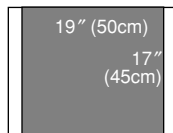

## 2045 Incise Drape

Incise Area	Drapes/Box	Boxes/Case
19" x 17" (50cm x 45cm)	10	4
<b>2045NS</b> (non-sterile) <i>Custom Packs Only</i>	200 ea/cs	

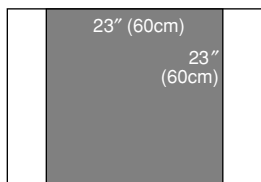

## 2050 Incise Drape

Incise Area	Drapes/Box	Boxes/Case
23" x 23" (60cm x 60cm)	10	4
<b>2050NS</b> (non-sterile) <i>Custom Packs Only</i>	200 ea/cs	

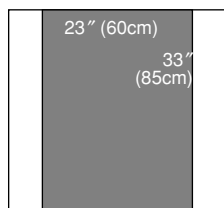

## 2051 Incise Drape

Incise Area	Drape/Box	Boxes/Case
23" x 33" (60cm x 85cm)	10	4
<b>2051NS</b> (non-sterile) <i>Custom Packs Only</i>	150 ea/cs	

### KEY

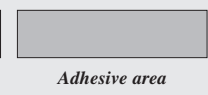
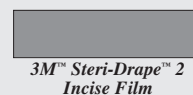
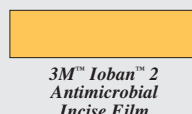
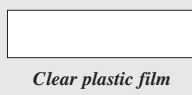
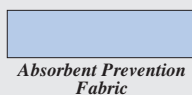

# 3M™ Steri-Drape™ INCISE DRAPES

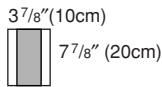

## 1035 Incise Drape

Incise Area	Drapes/Box	Boxes/Case
3 7/8" x 7 7/8" (10cm x 20cm)	10	4
<b>1035NS</b> (non-sterile) <i>Custom Packs Only</i>	200 ea/cs	

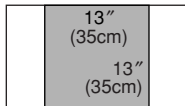

## 1040 Incise Drape

Incise Area	Drapes/Box	Boxes/Case
13" x 13" (35cm x 35cm)	10	4
<b>1040NS</b> (non-sterile) <i>Custom Packs Only</i>	200 ea/cs	

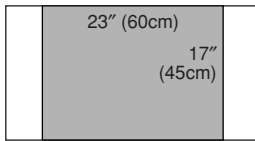

## 1050 Incise Drape

Incise Area	Drapes/Box	Boxes/Case
23" x 17" (60cm x 45cm)	10	4
<b>1050NS</b> (non-sterile) <i>Custom Packs Only</i>	200 ea/cs	

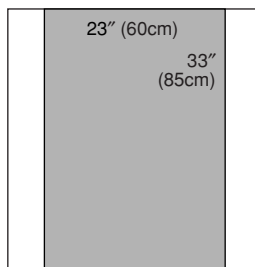

## 1051 Incise Drape

Incise Area	Drapes/Box	Boxes/Case
23" x 33" (60cm x 85cm)	10	4
<b>1051NS</b> (non-sterile) <i>Custom Packs Only</i>	150 ea/cs	

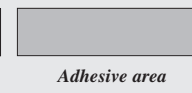
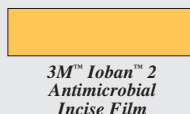
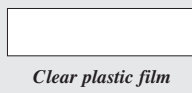
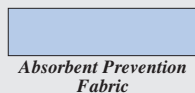

# 3M™ Steri-Drape™ ORTHOPAEDIC DRAPES

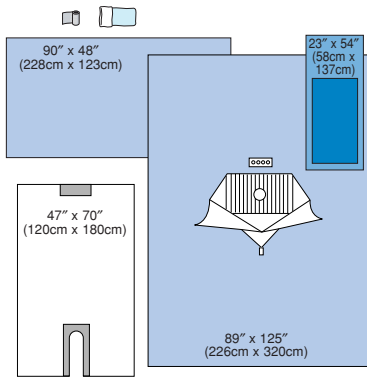

## 1095 Arthroscopy Pack

Name	Amount	Overall Size	Packs/Box	Box/Case
1094 Arthroscopy Sheet with Pouch	1	89" x 125" (226cm x 320cm)	5	1
1019 Long U-drape	1	47" x 70" (120cm x 180cm)		
Stockinette	1			
3M™ Coban™ Self-Adherent Wrap	1	4"		
9036 Mayo Stand Cover	1	23" x 54" (58cm x 137cm)		
Back Table Cover	1	90" x 48" (228cm x 123cm)		
1095NS (non-sterile) <i>Custom Packs Only</i>			10 ea/cs	

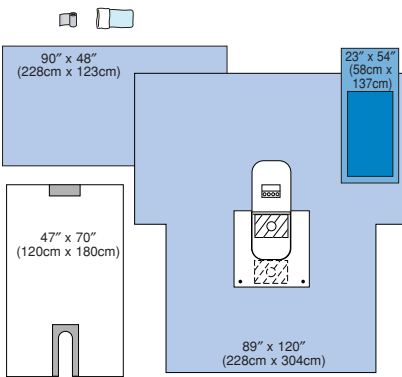

## 1195 Arthroscopy Pack

Name	Amount	Overall Size	Packs/Box	Box/Case
1194 Arthroscopy Sheet with Pouch	1	89" x 120" (228cm x 304cm)	5	1
1019 Long U-drape	1	47" x 70" (120cm x 180cm)		
Stockinette	1			
3M™ Coban™ Self-Adherent Wrap	1	4"		
9036 Mayo Stand Cover	1	23" x 54" (58cm x 137cm)		
Back Table Cover	1	90" x 48" (228cm x 123cm)		
1195NS ( <i>Custom Packs Only</i> )			10 ea/cs	

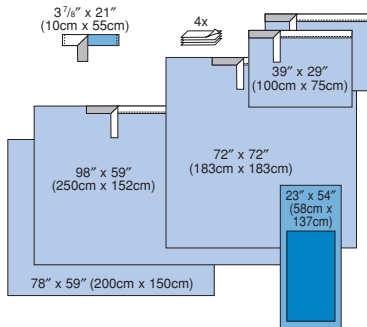

## 9000A Basic Surgical Pack

Name	Amount	Overall Size	Packs/Box	Boxes/Case
9099 OP Tape	1	3 7/8" x 21" (10cm x 55cm)	7	2
Hand Towels	4	-		
9036 Mayo Stand Cover	1	23" x 54" (58cm x 137cm)		
9086 Adhesive Towel Drapes	2	39" x 29" (100cm x 75cm)		
9087 Adhesive Drape Sheet (M)	1	72" x 72" (183cm x 183cm)		
9088 Adhesive Drape Sheet (L)	1	98" x 59" (250cm x 152cm)		
9077 Back Table Cover	1	78" x 59" (200cm x 150cm)		

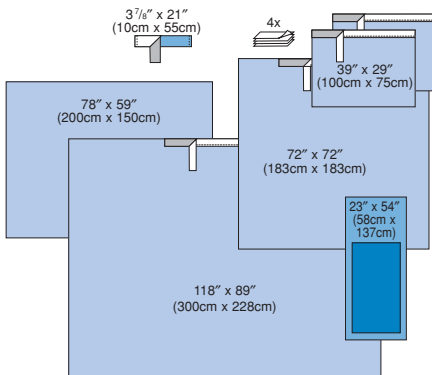

## 9000LA Basic Surgical Pack

Name	Amount	Overall Size	Packs/Box	Boxes/Case
9099 OP Tape	1	3 7/8" x 21" (10cm x 55cm)	5	2
Hand Towels	4	-		
9036 Mayo Stand Cover	1	23" x 54" (58cm x 137cm)		
9086 Adhesive Towel Drapes	2	39" x 29" (100cm x 75cm)		
9087 Adhesive Drape Sheet (M)	1	72" x 72" (183cm x 183cm)		
9090 Adhesive Drape Sheet (XL)	1	118" x 89" (300cm x 228cm)		
9077 Back Table Cover	1	78" x 59" (200cm x 150cm)		

**KEY**

Absorbent Prevention Fabric

Standard Blue Fabric (fluid-repellent)

Clear plastic film

3M™ Ioban™ 2 Antimicrobial Incise Film

3M™ Steri-Drape™ 2 Incise Film

Adhesive area

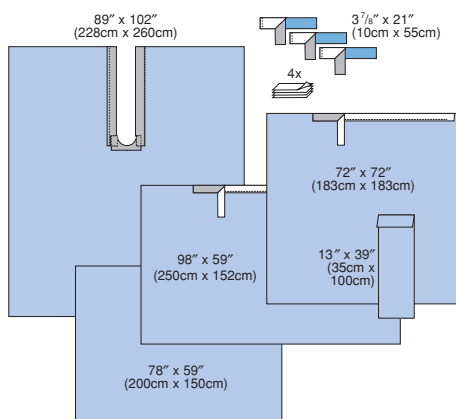

### 9002 Orthopaedic Pack without Mayo Stand Cover

Name	Amount	Overall Size	Packs/Box	Boxes/Case
9099 OP Tapes	3	3 7/8" x 21" (10cm x 55cm)	5	2
Hand Towels	4	-		
9042 Extremity Cover	1	13" x 39" (35cm x 100cm)		
9087 Adhesive Drape Sheet (M)	1	72" x 72" (183cm x 183cm)		
9045 Adhesive Split Sheet	1	89" x 102" (228cm x 260cm)		
9088 Adhesive Drape Sheet (L)	1	98" x 59" (250cm x 152cm)		
9077 Back Table Cover	1	78" x 59" (200cm x 150cm)		

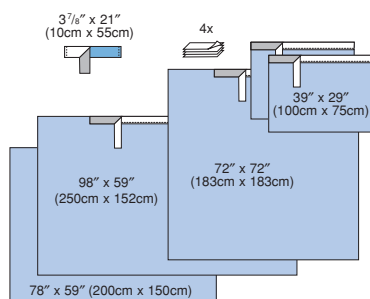

### 9010 Basic Surgical Pack without Mayo Stand Cover

Name	Amount	Overall Size	Packs/Box	Boxes/Case
9099 OP Tape	1	3 7/8" x 21" (10cm x 55cm)	7	2
Hand Towels	4	-		
9086 Adhesive Towel Drapes	2	39" x 29" (100cm x 75cm)		
9087 Adhesive Drape Sheet (M)	1	72" x 72" (183cm x 183cm)		
9088 Adhesive Drape Sheet (L)	1	98" x 59" (250cm x 152cm)		
9077 Back Table Cover	1	78" x 59" (200cm x 150cm)		

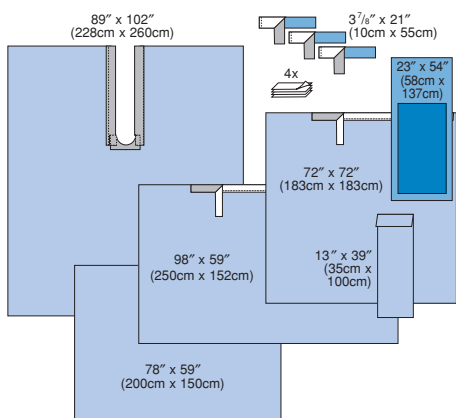

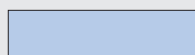

### 9012A Orthopaedic Pack

Name	Amount	Overall Size	Packs/Box	Boxes/Case
9099 OP Tape	1	3 7/8" x 21" (10cm x 55cm)	5	2
Hand Towels	4	-		
9036 Mayo Stand Cover	1	23" x 54" (58cm x 137cm)		
9042 Extremity Cover	1	13" x 39" (35cm x 100cm)		
9087 Adhesive Drape Sheet (M)	1	72" x 72" (183cm x 183cm)		
9045 Adhesive Split Sheet	1	89" x 102" (228cm x 260cm)		
9088 Adhesive Drape Sheet (L)	1	98" x 59" (250cm x 152cm)		
9077 Back Table Cover	1	78" x 59" (200cm x 150cm)		

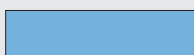
 Absorbent Prevention Fabric

 Standard Blue Fabric (fluid-repellent)

 Clear plastic film

 3M™ Ioban™ 2 Antimicrobial Incise Film

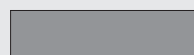
 3M™ Steri-Drape™ 2 Incise Film

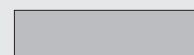
 Adhesive area

# 3M™ Steri-Drape™ ORTHOPAEDIC DRAPES

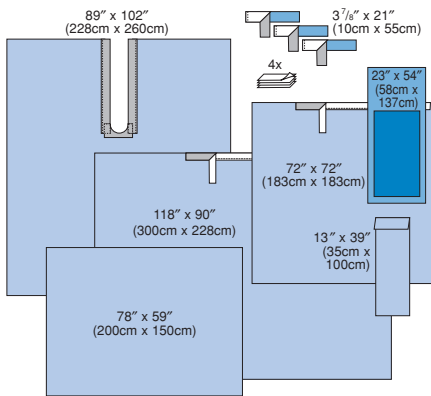

## 9012LA Orthopaedic Pack

Name	Amount	Overall Size	Packs/Box	Boxes/Case
9099 OP Tapes	3	3 7/8" x 21" (10cm x 55cm)	4	2
Hand Towels	4	-		
9036 Mayo Stand Cover	1	23" x 54" (58cm x 137cm)		
9042 Extremity Cover	1	13" x 39" (35cm x 100cm)		
9087 Adhesive Drape Sheet (M)	1	72" x 72" (183cm x 183cm)		
9045 Adhesive Split Sheet	1	89" x 102" (228cm x 260cm)		
9090 Adhesive Drape Sheet (XL)	1	118" x 90" (300cm x 228cm)		
9077 Back Table Cover	1	78" x 59" (200cm x 150cm)		

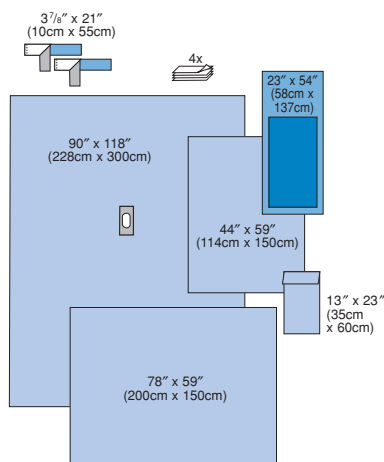

## 9014A Extremity Pack

Name	Amount	Overall Size	Packs/Box	Boxes/Case
9099 OP Tapes	2	3 7/8" x 21" (10cm x 55cm)	5	2
Hand Towels	4	-		
9036 Mayo Stand Cover	1	23" x 54" (58cm x 137cm)		
9072 Drape Sheet	1	44" x 59" (114cm x 150cm)		
9041 Extremity Cover	1	13" x 23" (35cm x 60cm)		
9053 Extremity Drape	1	90" x 118" (228cm x 300cm)		
9077 Back Table Cover	1	78" x 59" (200cm x 150cm)		

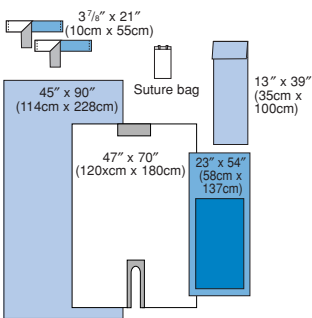

## 9021A Orthopaedic Set Up Pack

Name	Amount	Overall Size	Packs/Box	Boxes/Case
Suture Bag	1		15	2
9036 Mayo Stand Cover	1	23" x 54" (58cm x 137cm)		
9099 OP Tape	2	3 7/8" x 21" (10cm x 55cm)		
9042 Extremity Cover	1	13 1/2" x 39" (35cm x 100cm)		
1019 Long U-drape	1	47" x 70" (120cm x 180cm)		
Back Table Cover	1	45" x 90" (114cm x 228cm)		

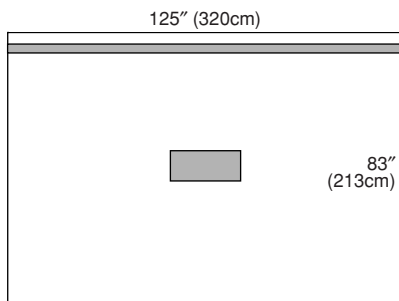

## 1014 Patient Isolation Drape

Overall Size	Drapes/Box	Boxes/Case
125" x 83" (320cm x 213cm)	5	4
• Incise area: 19" x 9 3/4" (50cm x 25cm)		
• Adhesive strip along top		
<b>1014NS</b> (non-sterile) <i>Custom Packs Only</i>	40 ea/cs	

### KEY

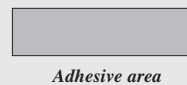
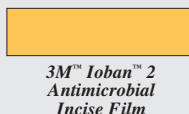
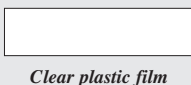
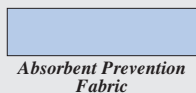



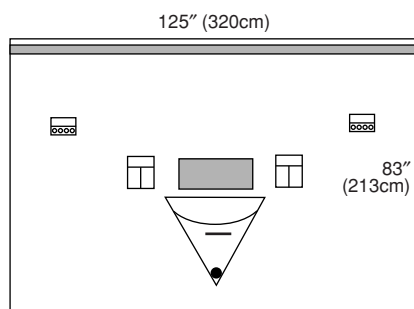

### 1017 Isolation Drape with Incise Film and Pouch

Overall Size	Drapes/Box	Boxes/Case
125" x 83" (320cm x 213cm)	5	4
<ul style="list-style-type: none"> <li>• Incise area: 19" x 9<sup>3</sup>/<sub>4</sub>" (50cm x 25cm)</li> <li>• Fluid collection pouch with screen</li> <li>• 1 – Exit port</li> <li>• 2 – Instrument pouches</li> <li>• 2 – Tube and cord organizers</li> <li>• Adhesive strip along top</li> </ul>		

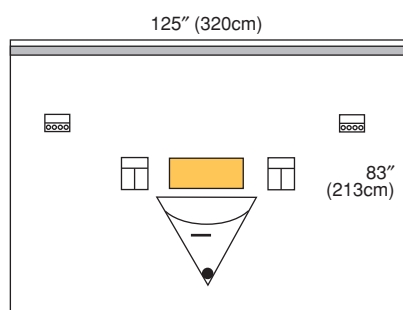

### 6617 Isolation Drape with Ioban™ 2 Incise Film and Pouch

Overall Size	Drapes/Box	Boxes/Case
125" x 83" (320cm x 213cm)	5	4
<ul style="list-style-type: none"> <li>• Ioban 2 antimicrobial incise area: 19" x 9<sup>3</sup>/<sub>8</sub>" (50cm x 24cm)</li> <li>• Fluid collection pouch with screen</li> <li>• 1 – Exit port</li> <li>• 2 – Instrument pouches</li> <li>• 2 – Tube and cord organizers</li> <li>• Adhesive strip along top</li> </ul>		

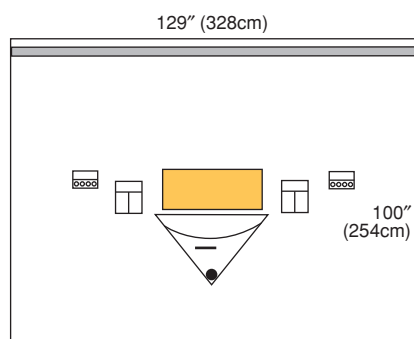

### 6619 Large Isolation Drape with Ioban 2 Incise Film and Pouch

Overall Size	Drapes/Box	Box/Case
129" x 100" (328cm x 254cm)	5	1
<ul style="list-style-type: none"> <li>• Ioban 2 antimicrobial incise area: 27" x 12" (70cm x 32cm)</li> <li>• Fluid collection pouch with screen</li> <li>• 1 – Exit port</li> <li>• 2 – Instrument pouches</li> <li>• 2 – Tube and cord organizers</li> </ul>		

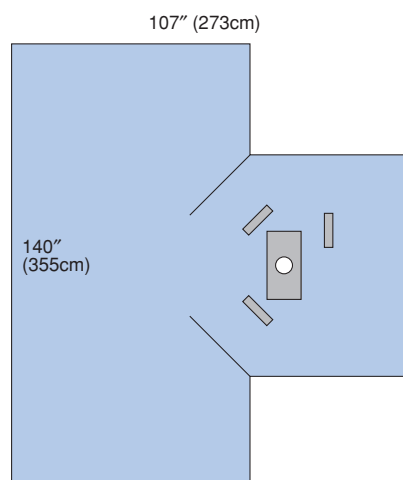

### 9052 Hand Drape

Overall Size	Drapes/Box	Boxes/Case
140" x 107" (355cm x 273cm)	9	2
<ul style="list-style-type: none"> <li>• Elastic circle aperture: 1" (3cm)</li> <li>• 3 – Tube and cord organizers</li> <li>• Absorbent Prevention Fabric</li> </ul>		
<b>9052NS</b> (non-sterile) <i>Custom Packs Only</i>	20 ea/cs	

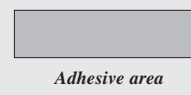
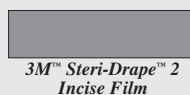
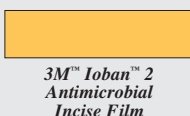
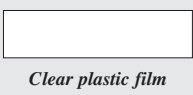
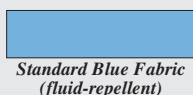
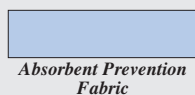

# 3M™ Steri-Drape™ ORTHOPAEDIC DRAPES

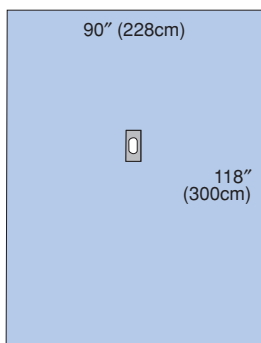

## 9053 Extremity Drape

Overall Size	Drapes/Box	Boxes/Case
90" x 118" (228cm x 300cm)	10	2
<ul style="list-style-type: none"> <li>• Elastic aperture: 2 1/4" x 3 1/8" (6cm x 8cm)</li> <li>• Absorbent Prevention Fabric</li> </ul>		
<b>9053NS</b> (non-sterile) <i>Custom Packs Only</i>	18 ea/cs	

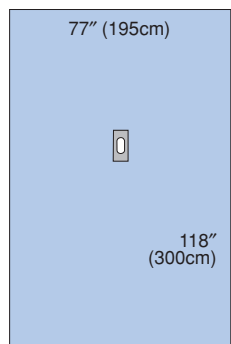

## 9054 Hand and Foot Drape

Overall Size	Drapes/Box	Boxes/Case
77" x 118" (195cm x 300cm)	12	2
<ul style="list-style-type: none"> <li>• Elastic aperture: 1" (3cm)</li> <li>• Absorbent Prevention Fabric</li> </ul>		
<b>9054NS</b> (non-sterile) <i>Custom Packs Only</i>	30 ea/cs	

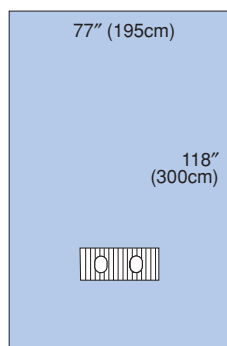

## 9056 Bilateral Foot Drape

Overall Size	Drapes/Box	Boxes/Case
77" x 118" (195cm x 300cm)	13	2
<ul style="list-style-type: none"> <li>• Elastic apertures: 1 1/2" (4cm)</li> <li>• Absorbent Prevention Fabric</li> </ul>		
<b>9056NS</b> (non-sterile) <i>Custom Packs Only</i>	28 ea/cs	

### KEY

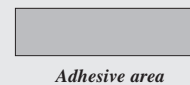
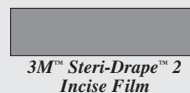
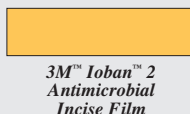
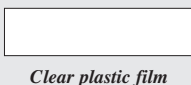
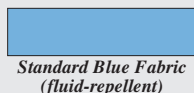
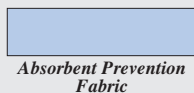

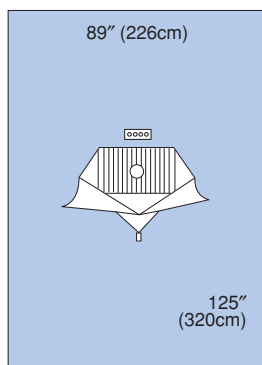

### 1094 Arthroscopy Drape with Pouch

Overall Size	Drape/Box	Boxes/Case
89" x 125" (226cm x 320cm)	20	1
<ul style="list-style-type: none"> <li>• Fluid collection pouch</li> <li>• 1 – Exit port</li> <li>• Tube and cord organiser</li> <li>• Absorbent Prevention Fabric</li> </ul>		
<b>1094NS</b> (non-sterile) <i>Custom Packs Only</i>	30 ea/cs	

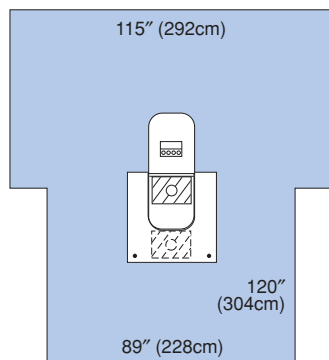

### 1194 Arthroscopy Drape with Pouch

Overall Size	Drape/Box	Box/Case
89" x 120" (228cm x 304cm)	5	1
<ul style="list-style-type: none"> <li>• Width at arm extensions: 115" (292cm)</li> <li>• Fluid collection pouch</li> <li>• 2 – Exit ports</li> <li>• Tube and cord organiser</li> <li>• Absorbent Prevention Fabric</li> </ul>		
<b>1194NS</b> (non-sterile) <i>Custom Packs Only</i>	16 ea/cs	

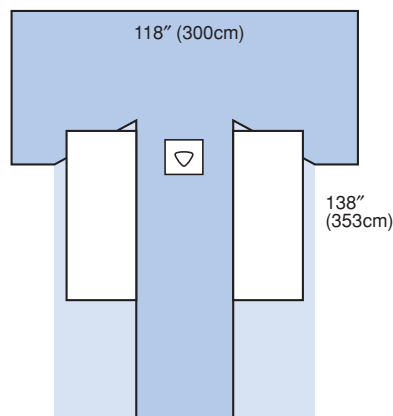

### 9055 Hip Drape

Overall Size	Drapes/Box	Box/Case
118" x 138" (300cm x 353cm)	8	2
<ul style="list-style-type: none"> <li>• Adhesive strip on the inside of the drape</li> <li>• Large side pockets with flaps for fluid collection and control</li> <li>• Absorbent Prevention Fabric</li> </ul>		
<b>9055NS</b> (non-sterile) <i>Custom Packs Only</i>	15 ea/cs	

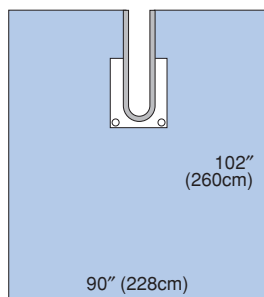

### 9196 Shoulder Split Sheet with Pouch

Overall Size	Drapes/Box	Boxes/Case
90" x 102" (228cm x 260cm)	10	2
<ul style="list-style-type: none"> <li>• Adhesive split: 6" x 37" (16cm x 95cm)</li> <li>• Fluid control pouch with 2 exit ports</li> <li>• Absorbent Prevention Fabric</li> </ul>		
<b>9196NS</b> (non-sterile) <i>Custom Packs Only</i>	25 ea/cs	

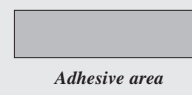
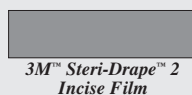
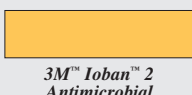
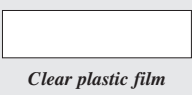
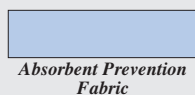

# 3M™ Steri-Drape™ ORTHOPAEDIC DRAPES

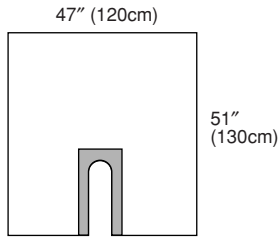

## 1015 U-drape

Overall Size	Drapes/Box	Boxes/Case
47" x 51" (120cm x 130cm)	10	4
• Adhesive split: 6 1/2" x 18" (16,5cm x 46cm)		
<b>1015NSD</b> (non-sterile)	100 ea/cs	
<b>1015NS</b> (non-sterile) <i>Custom Packs Only</i>	200 ea/cs	

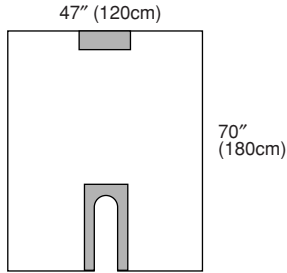

## 1019 Long U-drape

Overall Size	Drapes/Box	Boxes/Case
47" x 70" (120cm x 180cm)	10	4
• Adhesive split: 6 1/2" x 18" (16,5cm x 46cm)		
• Adhesive patch		
<b>1019NS</b> (non-sterile) <i>Custom Packs Only</i>	200 ea/cs	

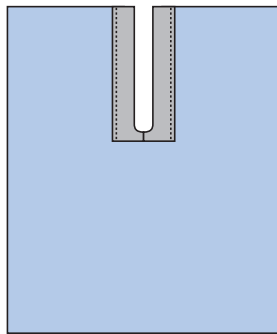

## Adhesive Split Sheets

	Overall Size	Drapes/Box	Boxes/Case
<i>Split size 2 1/2" x 25" (7x70cm)</i>			
<b>9043</b>	59" x 72" (152cm x 183cm)	30	2
<b>9044</b>	59" x 98" (152cm x 250cm)	25	2
<i>Split size 7" x 39" (20x100cm)</i>			
<b>9045</b>	89" x 102" (228cm x 260cm)	15	2
• Absorbent Prevention Fabric			
<b>9043NS</b> (non-sterile) <i>Custom Packs Only</i>		68 ea/cs	
<b>9044NS</b> (non-sterile) <i>Custom Packs Only</i>		58 ea/cs	
<b>9045NS</b> (non-sterile) <i>Custom Packs Only</i>		30 ea/cs	

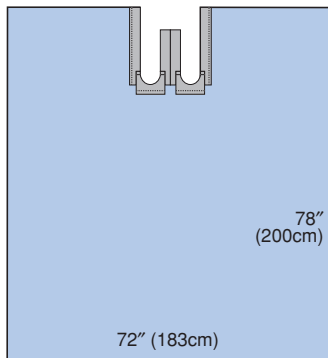

## 9046 Bilateral Split Sheet

Overall Size	Drapes/Box	Boxes/Case
72" x 78" (183cm x 200cm)	15	2
• Double adhesive split: 5 7/8" x 19" (15cm x 50cm)		
• Absorbent Prevention Fabric		
<b>9046NS</b> (non-sterile) <i>Custom Packs Only</i>	30 ea/cs	

### KEY

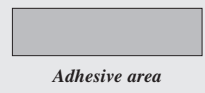
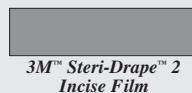
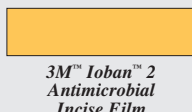
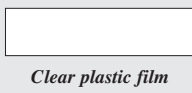
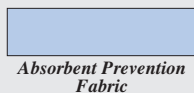

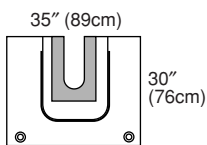

### 1067 U-pouch

Overall Size	Drapes/Box	Boxes/Case
35" x 30" (89cm x 76cm)	5	4
<ul style="list-style-type: none"> <li>• Adhesive split: 6" x 15" (16cm x 40cm)</li> <li>• Fluid collection pouch</li> <li>• 2 – Exit ports</li> </ul>		
<b>1067NS</b> (non-sterile) <i>Custom Packs Only</i>	50 ea/cs	

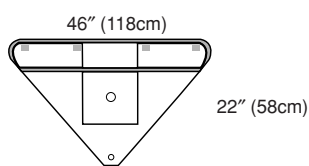

### 1007 Arthroscopy Fluid Collection Pouch

Overall Size	Drapes/Box	Boxes/Case
46" x 22" (118cm x 58cm)	10	4
<ul style="list-style-type: none"> <li>• Adhesive strips</li> <li>• 1 – Exit port</li> </ul>		

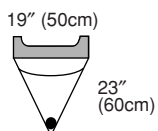

### 1016 Irrigation Pouch

Overall Size	Drapes/Box	Boxes/Case
19" x 23" (50cm x 60cm)	10	4
<ul style="list-style-type: none"> <li>• Adhesive strip</li> <li>• 1 – Exit port</li> <li>• Screen</li> </ul>		
<b>1016NS</b> (non-sterile) <i>Custom Packs Only</i>	200 ea/cs	

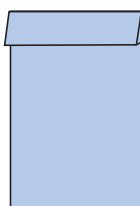

### Extremity Covers

	Overall Size	Drapes/Box	Boxes/Case
<b>9041</b>	13" x 23" (35cm x 60cm)	50	4
<b>9042</b>	13" x 39" (35cm x 100cm)	35	4
<ul style="list-style-type: none"> <li>• Absorbent Prevention Fabric</li> </ul>			
<b>9041NS</b> (non-sterile) <i>Custom Packs Only</i>		380 ea/cs	
<b>9042NS</b> (non-sterile) <i>Custom Packs Only</i>		250 ea/cs	

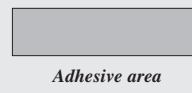
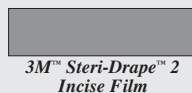
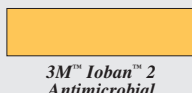
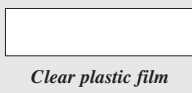
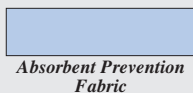

CARDIOVASCULAR/CARDIAC CATHETERIZATION DRAPES

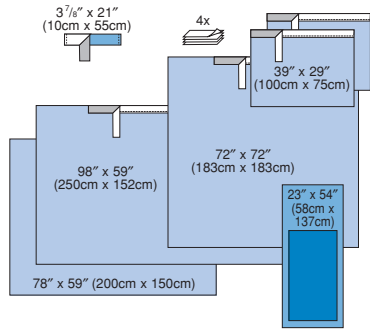

**9000A Basic Surgical Pack**

Name	Amount	Overall Size	Packs/Box	Boxes/Case
9099 OP Tape	1	3 7/8" x 21" (10cm x 55cm)	7	2
Hand Towels	4	-		
9036 Mayo Stand Cover	1	23" x 54" (58cm x 137cm)		
9086 Adhesive Towel Drapes	2	39" x 29" (100cm x 75cm)		
9087 Adhesive Drape Sheet (M)	1	72" x 72" (183cm x 183cm)		
9088 Adhesive Drape Sheet (L)	1	98" x 59" (250cm x 152cm)		
9077 Back Table Cover	1	78" x 59" (200cm x 150cm)		

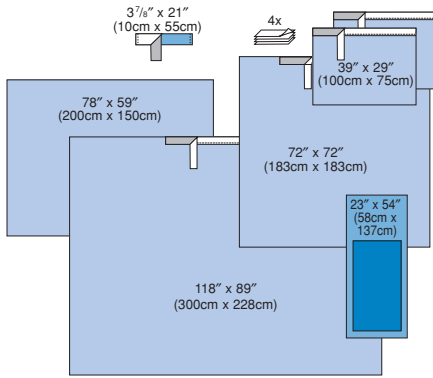

**9000LA Basic Surgical Pack**

Name	Amount	Overall Size	Packs/Box	Boxes/Case
9099 OP Tape	1	3 7/8" x 21" (10cm x 55cm)	5	2
Hand Towels	4	-		
9036 Mayo Stand Cover	1	23" x 54" (58cm x 137cm)		
9086 Adhesive Towel Drapes	2	39" x 29" (100cm x 75cm)		
9087 Adhesive Drape Sheet (M)	1	72" x 72" (183cm x 183cm)		
9090 Adhesive Drape Sheet (XL)	1	118" x 89" (300cm x 228cm)		
9077 Back Table Cover	1	78" x 59" (200cm x 150cm)		

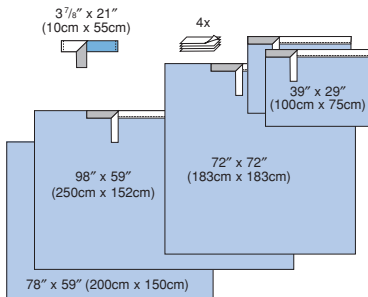

**9010 Basic Surgical Pack without Mayo Stand Cover**

Name	Amount	Overall Size	Packs/Box	Boxes/Case
9099 OP Tape	1	3 7/8" x 21" (10cm x 55cm)	7	2
Hand Towels	4	-		
9086 Adhesive Towel Drapes	2	39" x 29" (100cm x 75cm)		
9087 Adhesive Drape Sheet (M)	1	72" x 72" (183cm x 183cm)		
9088 Adhesive Drape Sheet (L)	1	98" x 59" (250cm x 152cm)		
9077 Back Table Cover	1	78" x 59" (200cm x 150cm)		

Cardiovascular Drapes

**KEY**

Absorbent Prevention Fabric

Standard Blue Fabric (fluid-repellent)

Clear plastic film

3M™ Ioban™ 2 Antimicrobial Incise Film

3M™ Steri-Drape™ 2 Incise Film

Adhesive area

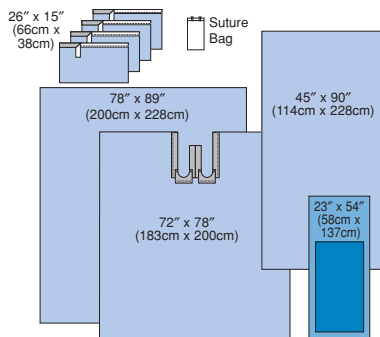

### 9022A Cardiovascular Set Up Pack

Name	Amount	Overall Size	Packs/Box	Boxes/Case
Suture Bag	1		7	2
9036 Mayo Stand Cover	1	23" x 54" (58cm x 137cm)		
9077 Back Table Cover	1	78" x 89" (200cm x 228cm)		
Utility Drapes	4	26" x 15" (66cm x 38cm)		
9046 Bilateral Split Sheet	1	72" x 78" (183cm x 200cm)		
Back Table Cover	1	45" x 90" (114cm x 228cm)		

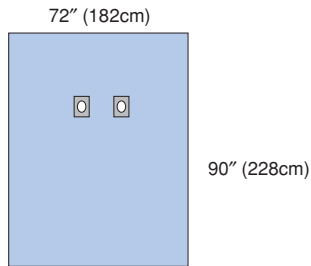

### 1090 Femoral Angiography Drape

Overall Size	Drapes/Box	Box/Case
72" x 90" (182cm x 228cm)	20	1
<ul style="list-style-type: none"> <li>• 2 – Adhesive patches: 4<sup>3</sup>/<sub>8</sub>" x 5<sup>1</sup>/<sub>2</sub>" (11,4cm x 14cm)</li> <li>• 2 – Oval apertures: 2<sup>1</sup>/<sub>2</sub>" x 3<sup>1</sup>/<sub>2</sub>" (6,4cm x 8,9cm)</li> <li>• Absorbent Prevention Fabric</li> </ul>		
<b>1090NS</b> (non-sterile) <i>Custom Packs Only</i>	50 ea/cs	

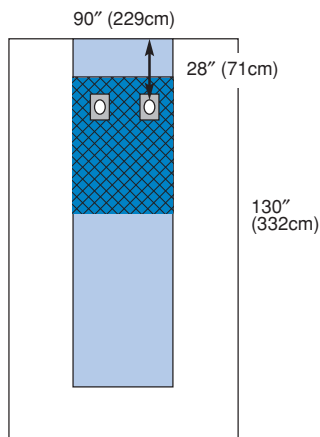

### 1191 Femoral Angiography Drape

Overall Size	Drapes/Box	Box/Case
90" x 130" (229cm x 332cm)	20	1
<ul style="list-style-type: none"> <li>• 2 – Adhesive patches: 4<sup>3</sup>/<sub>8</sub>" x 5<sup>1</sup>/<sub>2</sub>" (11,4cm x 14cm)</li> <li>• 2 – Oval apertures: 2<sup>7</sup>/<sub>8</sub>" x 4" (7,6cm x 10,2cm)</li> <li>• Extra-absorbent critical zone</li> <li>• Transparent side and end panels</li> <li>• Absorbent Prevention Fabric</li> </ul>		
<b>1191NS</b> (non-sterile) <i>Custom Packs Only</i>	20 ea/cs	

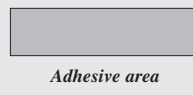
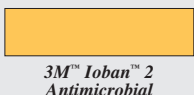
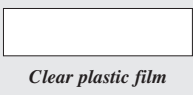

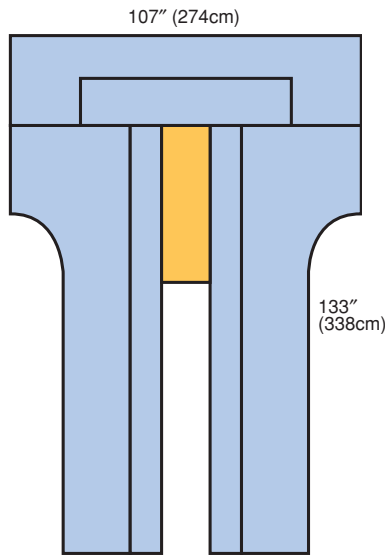

**6677 Cardiovascular Drape with loban 2 Incise Film**

Overall Size	Drapes/Box	Box/Case
107" x 133" (274cm x 338cm)	6	1
<ul style="list-style-type: none"> <li>• Ioban 2 antimicrobial incise area: 16" x 36" (41cm x 92cm)</li> <li>• Dual side pockets</li> <li>• Reinforced anesthesia screen</li> <li>• Absorbent Prevention Fabric</li> </ul>		

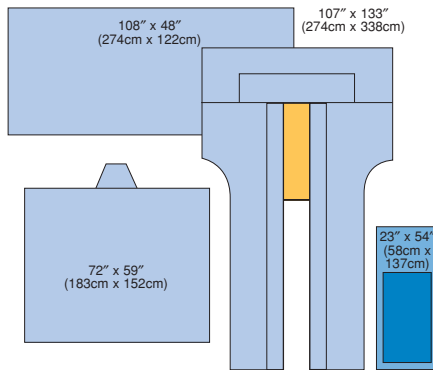

**6678 Cardiovascular Pack**

Name	Amount	Overall Size	Packs/Box	Boxes/Case
6677 Steri-Drape Cardiovascular Sheet with loban 2 Incise Film	1	107" x 133" (274cm x 338cm)	4	1
1083 Perineal/Leg Sheet	1	72" x 59" (183cm x 152cm)		
9036 Mayo Stand Cover	1	23" x 54" (58cm x 137cm)		
Back Table Cover	1	108" x 48" (274cm x 122cm)		

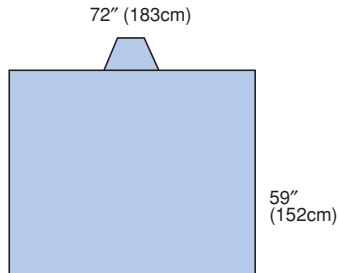

**1083 Perineal/Leg Sheet**

Overall Size	Drapes/Box	Boxes/Case
72" x 59" (183cm x 152cm)	50	2
<ul style="list-style-type: none"> <li>• Absorbent Prevention Fabric</li> </ul>		
<b>1083NS</b> (non-sterile) <i>Custom Packs Only</i>	90 ea/cs	

**KEY**





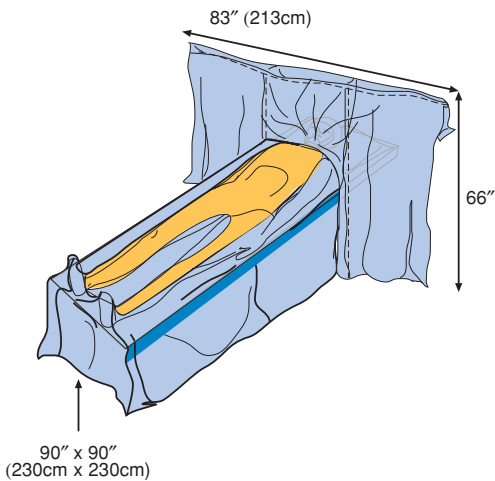

### 6681 Cardiovascular Drape with Ioban 2 Incise Film

Overall Size	Drapes/Box	Box/Case
90" x 90" (230cm x 230cm)	8	1
<ul style="list-style-type: none"> <li>• Width at arm extensions: 83" (213cm)</li> <li>• Ioban 2 antimicrobial incise area: 11" x 59" (30cm x 152cm)</li> <li>• One-piece design</li> <li>• Expansion pleat between legs</li> <li>• Blue anesthesia screen</li> <li>• Ioban 2 antimicrobial incise film in both chest and leg areas</li> <li>• Absorbent Prevention Fabric</li> </ul>		

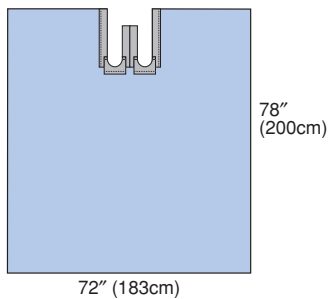

### 9046 Bilateral Split Sheet

Overall Size	Drapes/Box	Boxes/Case
72" x 78" (183cm x 200cm)	15	2
<ul style="list-style-type: none"> <li>• Double adhesive split: 5 7/8" x 19" (15cm x 50cm)</li> <li>• Absorbent Prevention Fabric</li> </ul>		
<b>9046NS</b> (non-sterile) <i>Custom Packs Only</i>	30 ea/cs	

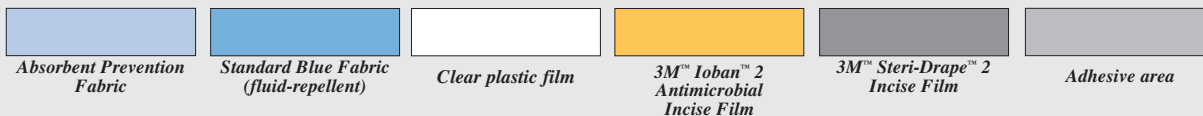

# OBSTETRICS AND GYNAECOLOGY DRAPES

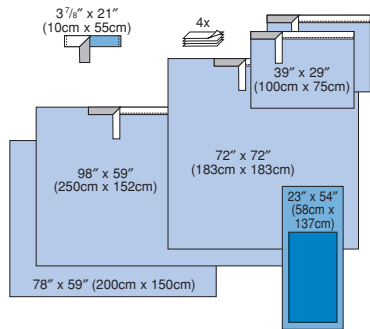

## 9000A Basic Surgical Pack

Name	Amount	Overall Size	Packs/Box	Boxes/Case
9099 OP Tape	1	37/8" x 21" (10cm x 55cm)	7	2
Hand Towels	4	-		
9036 Mayo Stand Cover	1	23" x 54" (58cm x 137cm)		
9086 Adhesive Towel Drapes	2	39" x 29" (100cm x 75cm)		
9087 Adhesive Drape Sheet (M)	1	72" x 72" (183cm x 183cm)		
9088 Adhesive Drape Sheet (L)	1	98" x 59" (250cm x 152cm)		
9077 Back Table Cover	1	78" x 59" (200cm x 150cm)		

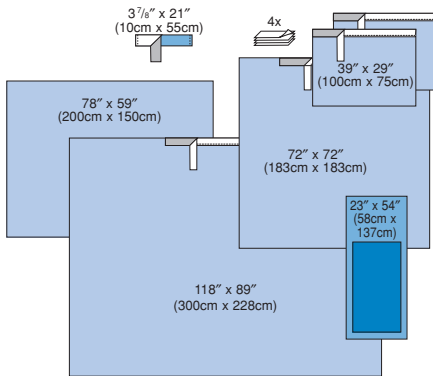

## 9000LA Basic Surgical Pack

Name	Amount	Overall Size	Packs/Box	Boxes/Case
9099 OP Tape	1	37/8" x 21" (10cm x 55cm)	5	2
Hand Towels	4	-		
9036 Mayo Stand Cover	1	23" x 54" (58cm x 137cm)		
9086 Adhesive Towel Drapes	2	39" x 29" (100cm x 75cm)		
9087 Adhesive Drape Sheet (M)	1	72" x 72" (183cm x 183cm)		
9090 Adhesive Drape Sheet (XL)	1	118" x 89" (300cm x 228cm)		
9077 Back Table Cover	1	78" x 59" (200cm x 150cm)		

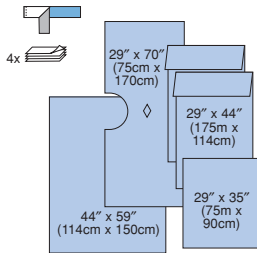

## 9003 Cystoscopy Pack

Name	Amount	Overall Size	Packs/Box	Boxes/Case
9099 OP Tape	1	37/8" x 21" (10cm x 55cm)	10	2
Hand Towels	4	-		
9040 Leggings (pair)	1	29" x 44" (75cm x 114cm)		
9069 Drape Sheet	1	29" x 35" (75cm x 90cm)		
Perineal Aperture Drape	1	29" x 70" (75cm x 170cm)		
9072 Back Table Cover	1	44" x 59" (114cm x 150cm)		

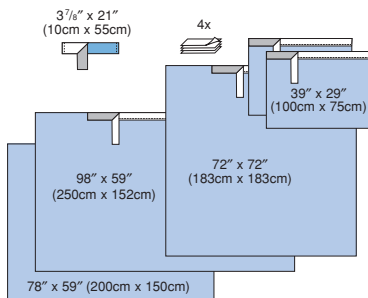

## 9010 Basic Surgical Pack without Mayo Stand Cover

Name	Amount	Overall Size	Packs/Box	Boxes/Case
9099 OP Tape	1	37/8" x 21" (10cm x 55cm)	7	2
Hand Towels	4	-		
9086 Adhesive Towel Drapes	2	39" x 29" (100cm x 75cm)		
9087 Adhesive Drape Sheet (M)	1	72" x 72" (183cm x 183cm)		
9088 Adhesive Drape Sheet (L)	1	98" x 59" (250cm x 152cm)		
9077 Back Table Cover	1	78" x 59" (200cm x 150cm)		

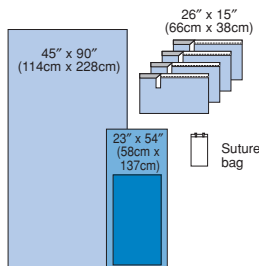

## 9020A Basic Set-Up Pack

Name	Amount	Overall Size	Packs/Box	Boxes/Case
Suture Bag	1		20	2
9036 Mayo Stand Cover	1	23" x 54" (58cm x 137cm)		
Utility Drapes	4	26" x 15" (66cm x 38cm)		
Back Table Cover	1	45" x 90" (114cm x 228cm)		

**KEY**

Absorbent Prevention Fabric

Standard Blue Fabric (fluid-repellent)

Clear plastic film

3M™ Ioban™ 2 Antimicrobial Incise Film

3M™ Steri-Drape™ 2 Incise Film

Adhesive area

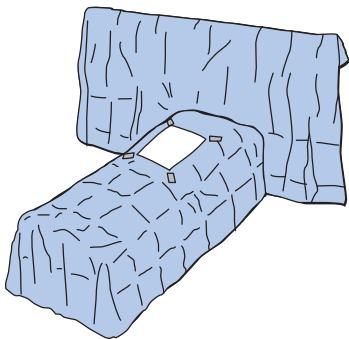

### 1031 Laparoscopy Drape - Supine Position

Overall Size	Drapes/Box	Boxes/Case
112" x 72" (285cm x 182cm)	10	2
<ul style="list-style-type: none"> <li>• Width at arm extensions: 90" (228cm)</li> <li>• Adhesive aperture: 10" x 11" (27cm x 30cm)</li> <li>• 4 – Tube organizers (ref.1115)</li> <li>• Absorbent Prevention Fabric</li> </ul>		
<b>1031NS</b> (non-sterile) <i>Custom Packs Only</i>	30 ea/cs	

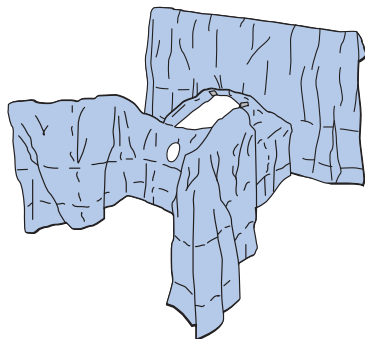

### 1032 Laparoscopy Drape - Lithotomy Position

Overall Size	Drapes/Box	Boxes/Case
95" (214cm)	8	2
<ul style="list-style-type: none"> <li>• Width at arm extensions: 89" (228cm)</li> <li>• Adhesive aperture: 10" x 11" (27cm x 30cm)</li> <li>• Peri/vag. aperture: 4<sup>5</sup>/<sub>8</sub>" x 6" (12cm x 15,5cm)</li> <li>• Leggings: 46" (117cm)</li> <li>• 4 – Tube organizers (ref.1115)</li> <li>• Absorbent Prevention Fabric</li> </ul>		
<b>1032NS</b> (non-sterile) <i>Custom Packs Only</i>	20 ea/cs	

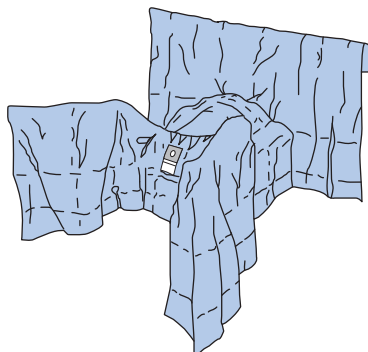

### 1080 Gynaecology Drape with Pouch

Overall Size	Drapes/Box	Boxes/Case
77" x 70" (195cm x 179cm)	14	2
<ul style="list-style-type: none"> <li>• Peri/vag. aperture: 3<sup>1</sup>/<sub>2</sub>" x 4<sup>1</sup>/<sub>2</sub>" (9cm x 11cm)</li> <li>• Tube and cord organizers (ref.1115)</li> <li>• Fluid collection pouch (ref. 1072)</li> <li>• Absorbent Prevention Fabric</li> </ul>		
<b>1080NS</b> (non-sterile) <i>Custom Packs Only</i>	30 ea/cs	



### 2065 Abdominal-Perineal Drape - Lithotomy Position

Overall Size	Drapes/Box	Boxes/Case
77" x 160" (195cm x 270cm)	8	2
<ul style="list-style-type: none"> <li>• Steri-Drape 2 incise area: 16" x 17" (41cm x 45cm)</li> <li>• Peri/vag. aperture: 4<sup>5</sup>/<sub>8</sub>" x 6" (12cm x 15,5cm)</li> <li>• Tube and cord organizers (ref.1115)</li> <li>• Absorbent Prevention Fabric</li> </ul>		
<b>2065NS</b> (non-sterile) <i>Custom Packs Only</i>	20 ea/cs	

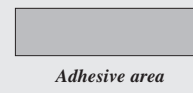
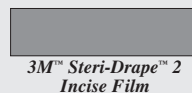
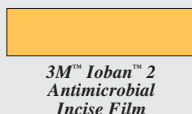
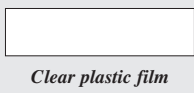
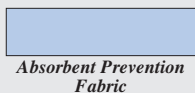

# OBSTETRICS AND GYNAECOLOGY DRAPES

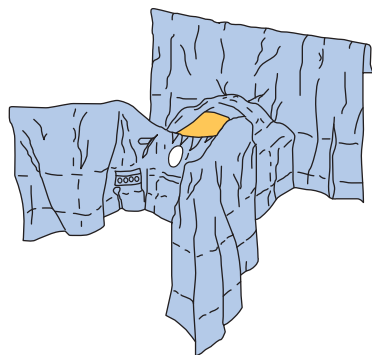

## 6665 Ioban 2 Abdominal-Perineal Drape - Lithotomy Position

Overall Size	Drapes/Box	Box/Case
78" x 106" (200cm x 270cm)	5	1

- Ioban 2 antimicrobial incise area:  
13" x 18" (35cm x 46cm)
- Peri/vag. aperture: 4<sup>5</sup>/<sub>8</sub>" x 6" (12cm x 15,5cm)
- Tube and cord organizers (ref.1115)
- Absorbent Prevention Fabric

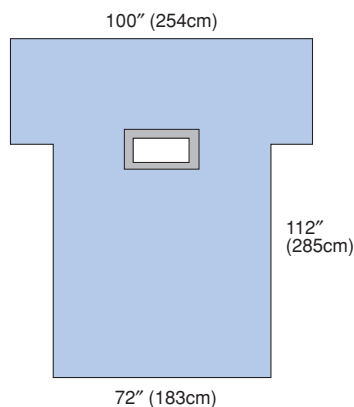

## 9062 Laparotomy Drape (transverse)

Overall Size	Drapes/Box	Boxes/Case
72" x 112" (183cm x 285cm)	12	2

- Width at arm extensions: 100" (254cm)
- Aperture: 12" x 4" (30cm x 10cm)
- Absorbent Prevention Fabric

<b>9062NS</b> (non-sterile) <i>Custom Packs Only</i>	26 ea/cs	
--	----------	--

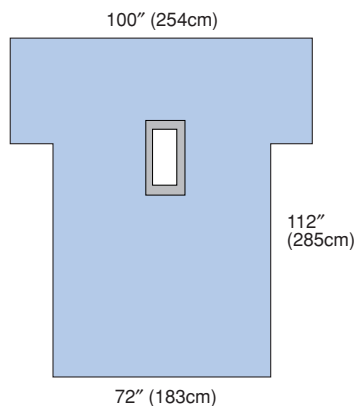

## 9063 Laparotomy Drape

Overall Size	Drapes/Box	Boxes/Case
72" x 112" (183cm x 285cm)	10	2

- Width at arm extensions: 100" (254cm)
- Aperture: 3<sup>7</sup>/<sub>8</sub>" x 12" (10cm x 30cm)
- Absorbent Prevention Fabric

<b>9063NS</b> (non-sterile) <i>Custom Packs Only</i>	24 ea/cs	
--	----------	--

### KEY

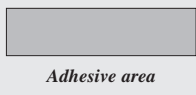
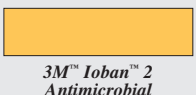
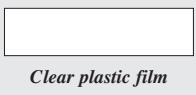
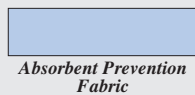

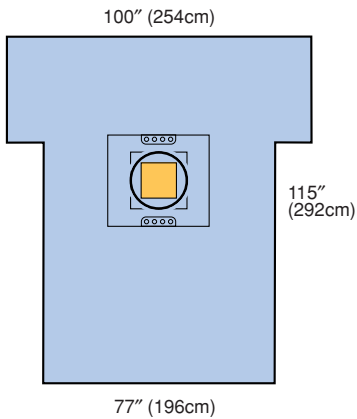

### 6697 Cesarean Section Drape with Ioban 2 Incise Pouch

Overall Size	Drapes/Box	Box/Case
77" x 115" (196cm x 292cm)	5	1
<ul style="list-style-type: none"> <li>• Width at arm extensions: 100" (254cm)</li> <li>• Ioban 2 antimicrobial incise area: 12" x 12" (30cm x 30cm)</li> <li>• 360-degree fluid collection pouch</li> <li>• Tube and cord organizers</li> <li>• Absorbent Prevention Fabric</li> </ul>		

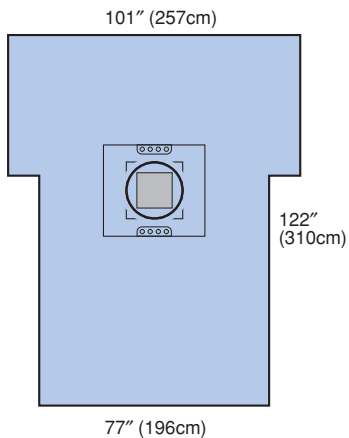

### 7965 Cesarean Section Drape with Incise Pouch

Overall Size	Drapes/Box	Box/Case
77" x 122" (196cm x 310cm)	5	1
<ul style="list-style-type: none"> <li>• Width at arm extensions: 101" (257cm)</li> <li>• Incise area: 12" x 12" (30cm x 30cm)</li> <li>• 360-degree fluid collection pouch</li> <li>• Tube and cord organizers</li> <li>• Absorbent Prevention Fabric</li> </ul>		
<b>7965NS</b> (non-sterile) <i>Custom Packs Only</i>	18 ea/cs	

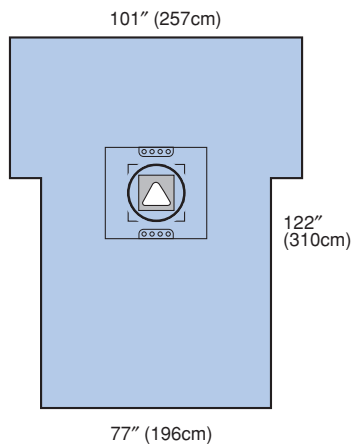

### 7966 Cesarean Section Drape with Adhesive Aperture Pouch

Overall Size	Drapes/Box	Box/Case
77" x 122" (196cm x 310cm)	5	1
<ul style="list-style-type: none"> <li>• Width at arm extensions: 101" (257cm)</li> <li>• Aperture incise area: 12" x 12" (30cm x 30cm)</li> <li>• 360-degree fluid collection pouch</li> <li>• Tube and cord organizers</li> <li>• Absorbent Prevention Fabric</li> </ul>		
<b>7966NS</b> (non-sterile) <i>Custom Packs Only</i>	18 ea/cs	

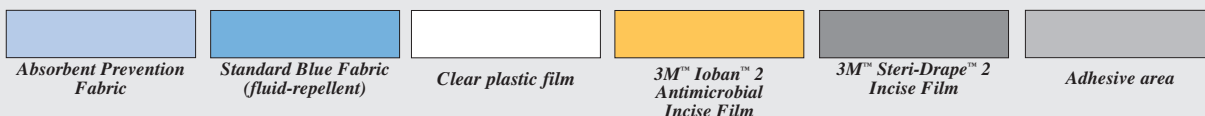

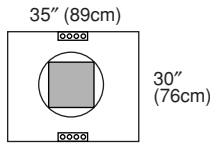

**2057 Incise Pouch**

Overall Size	Drapes/Box	Boxes/Case
35" x 30" (89cm x 76cm)	10	4

- Incise area: 12" x 12" (30cm x 30cm)
- 360-degree fluid collection pouch
- Tube and cord organizers

<b>2057NS</b> (non-sterile) <i>Custom Packs Only</i>	100 ea/cs
--	-----------

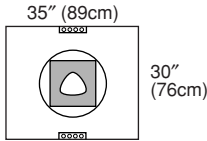

**2058 Aperture Pouch**

Overall Size	Drapes/Box	Boxes/Case
35" x 30" (89cm x 76cm)	10	4

- Aperture incise area: 12" x 12" (30cm x 30cm)
- 360-degree fluid collection pouch
- Tube and cord organizers

<b>2058NS</b> (non-sterile) <i>Custom Packs Only</i>	100 ea/cs
--	-----------

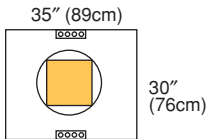

**6657 Pouch with Ioban 2 Incise Film**

Overall Size	Drapes/Box	Boxes/Case
35" x 30" (89cm x 76cm)	10	4

- Ioban 2 antimicrobial incise area: 12" x 12" (30cm x 30cm)
- 360-degree fluid collection pouch
- Tube and cord organizers

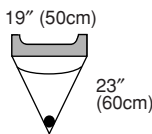

**1016 Irrigation Pouch**

Overall Size	Drapes/Box	Boxes/Case
Size: 19" x 23" (50cm x 60cm)	10	4

- Adhesive strip
- 1 – Exit port
- Screen

<b>1016NS</b> (non-sterile) <i>Custom Packs Only</i>	200 ea/cs
--	-----------

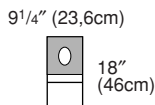

**1072 Aperture Pouch Drape**

Overall Size	Packs/Box	Boxes/Case
9 1/4" x 18" (23,6cm x 46cm)	10	4

- Adhesive area: 9 1/4" x 10" (23,6cm x 26cm)
- Oval aperture: 3 1/2" x 4 1/4" (9,2cm x 11,6cm)
- Fluid collection pouch

<b>1072NS</b> (non-sterile) <i>Custom Packs Only</i>	200 ea/cs
--	-----------

**KEY**

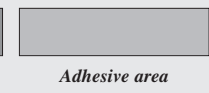
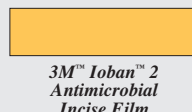
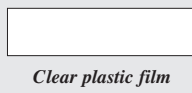
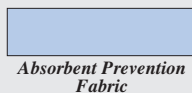

34" (86cm)

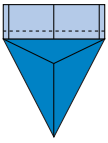

42"  
(108cm)

### 1084 Under Buttocks Drape with Pouch

Overall Size	Drapes/Box	Box/Case
34" x 42" (86cm x 108cm)	30	4
<ul style="list-style-type: none"> <li>• Cuff size: 10" (27cm)</li> <li>• Fluid collection pouch</li> <li>• Absorbent Prevention Fabric</li> </ul>		
<b>1084NS</b> (non-sterile) <i>Custom Packs Only</i>	140 ea/cs	

29" (75cm)

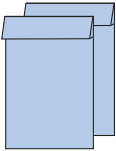

44"  
(114cm)

### 9040 Leggings (pair)

Overall Size	Drapes/Box	Boxes/Case
29" x 44" (75cm x 114cm)	10	4
<ul style="list-style-type: none"> <li>• Absorbent Prevention Fabric</li> </ul>		
<b>9040NS</b> (non-sterile) <i>Custom Packs Only</i>	116 ea/cs	

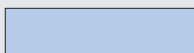

Absorbent Prevention Fabric



Standard Blue Fabric (fluid-repellent)



Clear plastic film



3M<sup>™</sup> Ioban<sup>™</sup> 2 Antimicrobial Incise Film

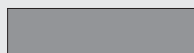

3M<sup>™</sup> Steri-Drape<sup>™</sup> 2 Incise Film

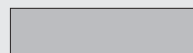

Adhesive area

# 3M™ Steri-Drape™ EENT DRAPES

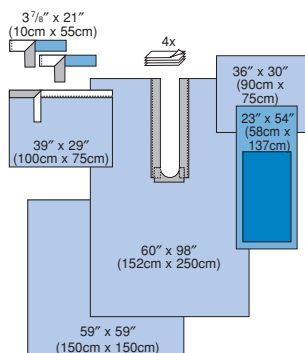

## 9007A EENT Pack

Name	Amount	Overall Size	Packs/Box	Boxes/Case
9099 OP Tape	2	3 7/8" x 21" (10cm x 55cm)	8	2
Hand Towels	4	-		
9036 Mayo Stand Cover	1	23" x 54" (58cm x 137cm)		
9069 Drape Sheet	1	36" x 30" (90cm x 75cm)		
9044 Adhesive Split Sheet	1	60" x 98" (152cm x 250cm)		
9086 Adhesive Towel Drape	1	39" x 29" (100cm x 75cm)		
Back Table Cover	1	59" x 59" (150cm x 150cm)		

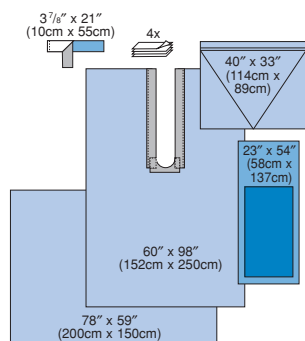

## 9008A Head and Neck Pack

Name	Amount	Overall Size	Packs/Box	Boxes/Case
9099 OP Tape	1	3 7/8" x 21" (10cm x 55cm)	8	2
Hand Towels	4	-		
9036 Mayo Stand Cover	1	23" x 54" (58cm x 137cm)		
Turban Drape Sheet	1	40" x 33" (114cm x 89cm)		
9044 Adhesive Split Sheet	1	60" x 98" (152cm x 250cm)		
9077 Back Table Cover	1	78" x 59" (200cm x 150cm)		

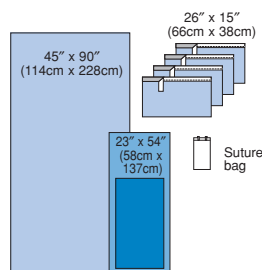

## 9020A Basic Set-Up Pack

Name	Amount	Overall Size	Packs/Box	Boxes/Case
Suture Bag	1		20	2
9036 Mayo Stand Cover	1	23" x 54" (58cm x 137cm)		
Utility Drapes	4	26" x 15" (66cm x 38cm)		
Back Table Cover	1	45" x 90" (114cm x 228cm)		

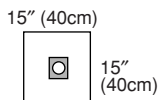

## 1020 Small Drape with Adhesive Aperture

Overall Size	Drapes/Box	Boxes/Case
15" x 15" (40cm x 40cm)	10	4
• Adhesive area: 3 7/8" x 4 7/8" (10cm x 12,5cm)		
• Circle aperture: 2 3/8" (6,3cm)		
<b>1020NS</b> (non-sterile) <i>Custom Packs Only</i>	200 ea/cs	

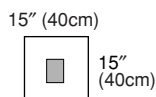

## 1021 Small Drape with Incise Film

Overall Size	Drapes/Box	Boxes/Case
15" x 15" (40cm x 40cm)	10	4
• Incise area: 3 7/8" x 4 7/8" (10cm x 12,5cm)		
<b>1021NS</b> (non-sterile) <i>Custom Packs Only</i>	200 ea/cs	



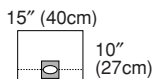

### 1022 Refractive Drape

Overall Size	Drapes/Box	Box/Case
15" x 10" (40cm x 27cm)	20	4
<ul style="list-style-type: none"> <li>• Adhesive area: 2 3/4" x 2 3/4" (7cm x 7cm)</li> <li>• Oval aperture: 1 3/4" x 1 1/2" (4,5cm x 3,8cm)</li> <li>• Perforated</li> </ul>		
<b>1022NS</b> (non-sterile) <i>Custom Packs Only</i>	200 ea/cs	

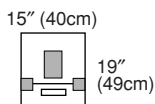

### 1023 Small Drape with Incise Film and Pouch

Overall Size	Drapes/Box	Boxes/Case
15" x 19" (40cm x 49cm)	10	4
<ul style="list-style-type: none"> <li>• Incise area: 3 7/8" x 4 7/8" (10cm x 12,5cm)</li> <li>• 2 – Adhesive patches</li> <li>• Fluid collection pouch</li> </ul>		
<b>1023NS</b> (non-sterile) <i>Custom Packs Only</i>	200 ea/cs	

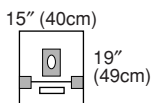

### 1024 Small Drape with Adhesive Aperture and Pouch

Overall Size	Drapes/Box	Boxes/Case
15" x 19" (40cm x 49cm)	10	4
<ul style="list-style-type: none"> <li>• Adhesive area: 3 7/8" x 4 7/8" (10cm x 12,5cm)</li> <li>• Oval aperture: 1 3/8" x 2 3/8" (3,5cm x 6,3cm)</li> <li>• 2 – Adhesive patches</li> <li>• Fluid collection pouch</li> </ul>		
<b>1024NS</b> (non-sterile) <i>Custom Packs Only</i>	200 ea/cs	

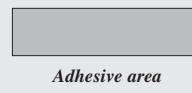
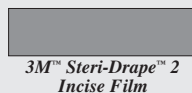
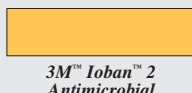
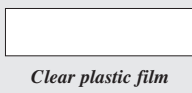
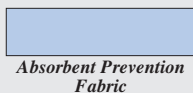

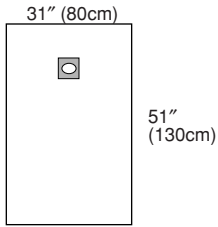

### 1030 Medium Drape with Adhesive Aperture

Overall Size	Drapes/Box	Boxes/Case
31" x 51" (80cm x 130cm)	10	4
<ul style="list-style-type: none"> <li>• Adhesive area: 3<sup>7</sup>/<sub>8</sub>" x 4<sup>7</sup>/<sub>8</sub>" (10cm x 12,5cm)</li> <li>• Oval aperture: 2" x 2<sup>7</sup>/<sub>8</sub>" (5,2cm x 7,6cm)</li> </ul>		
<b>1030NS</b> (non-sterile) <i>Custom Packs Only</i>	200 ea/cs	

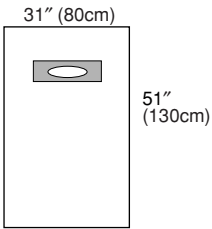

### 1033 Medium Drape with Wide Adhesive Aperture

Overall Size	Drapes/Box	Boxes/Case
31" x 51" (80cm x 130cm)	10	4
<ul style="list-style-type: none"> <li>• Adhesive area: 9" x 4<sup>3</sup>/<sub>8</sub>" (22,9cm x 11,4cm)</li> <li>• Oval aperture: 6<sup>5</sup>/<sub>8</sub>" x 2<sup>5</sup>/<sub>8</sub>" (17,1cm x 6,7cm)</li> </ul>		
<b>1033NS</b> (non-sterile) <i>Custom Packs Only</i>	200 ea/cs	

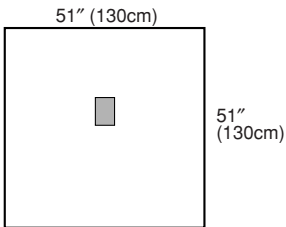

### 1060 Medium Drape with Incise Film

Overall Size	Drapes/Box	Boxes/Case
51" x 51" (130cm x 130cm)	10	4
<ul style="list-style-type: none"> <li>• Incise area: 3<sup>7</sup>/<sub>8</sub>" x 4<sup>7</sup>/<sub>8</sub>" (10cm x 12,5cm)</li> </ul>		
<b>1060NS</b> (non-sterile) <i>Custom Packs Only</i>	200 ea/cs	

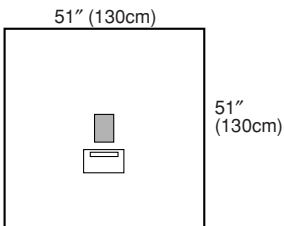

### 1061 Medium Drape with Incise Film and Pouch

Overall Size	Drapes/Box	Boxes/Case
51" x 51" (130cm x 130cm)	10	4
<ul style="list-style-type: none"> <li>• Incise area: 3<sup>7</sup>/<sub>8</sub>" x 4<sup>7</sup>/<sub>8</sub>" (10cm x 12,5cm)</li> <li>• Fluid collection pouch</li> </ul>		
<b>1061NS</b> (non-sterile) <i>Custom Packs Only</i>	200 ea/cs	

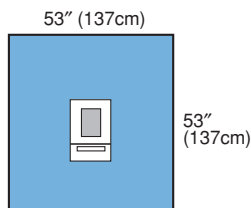

### 1062 Ophthalmic Drape with Incise Film and Pouch

Overall Size	Drapes/Box	Box/Case
53" x 53" (137cm x 137cm)	30	2
<ul style="list-style-type: none"> <li>• Incise area: 3 1/8" x 3 7/8" (8cm x 10cm)</li> <li>• Fluid collection pouch</li> <li>• Standard Blue Fabric</li> </ul>		
<b>1062NS</b> (non-sterile) <i>Custom Packs Only</i>	100 ea/cs	

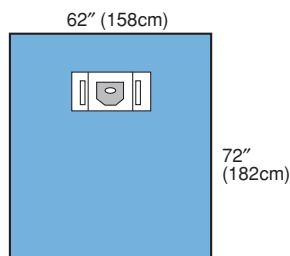

### 1064 Ophthalmic Drape with Aperture and Pouches

Overall Size	Drapes/Box	Boxes/Case
62" x 72" (158cm x 182cm)	20	2
<ul style="list-style-type: none"> <li>• Adhesive area: 3 1/2" x 4 1/2" (9cm x 11,7cm)</li> <li>• Oval aperture: 2 1/8" x 1 1/8" (5,7cm x 2,9cm)</li> <li>• 2 – Fluid collection pouches</li> <li>• Standard Blue Fabric</li> </ul>		
<b>1064NS</b> (non-sterile) <i>Custom Packs Only</i>	54 ea/cs	

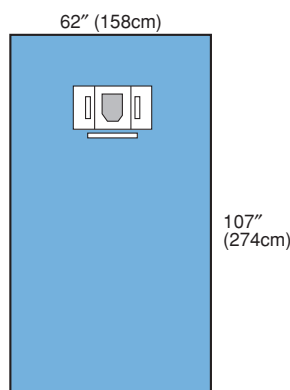

### 1055B Large Ophthalmic Drape with Incise Film and Pouches

Overall Size	Drapes/Box	Box/Case
62" x 108" (158cm x 274cm)	14	2
<ul style="list-style-type: none"> <li>• Incise area: 3 1/2" x 4 1/2" (9cm x 11,7cm)</li> <li>• 2 – Fluid collection pouches</li> <li>• Face arch</li> <li>• Standard Blue Fabric</li> </ul>		
<b>1055NS</b> (non-sterile) <i>Custom Packs Only</i>	35 ea/cs	

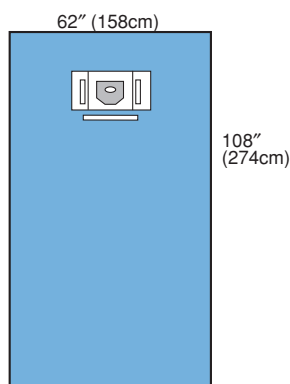

### 1065B Large Ophthalmic Drape with Aperture and Pouches

Overall Size	Drapes/Box	Box/Case
62" x 108" (158cm x 274cm)	14	2
<ul style="list-style-type: none"> <li>• Adhesive area: 3 1/2" x 4 1/2" (9cm x 11,7cm)</li> <li>• Oval aperture: 2 1/8" x 1 1/8" (5,7cm x 2,9cm)</li> <li>• 2 – Fluid collection pouches</li> <li>• Face arch</li> <li>• Standard Blue Fabric</li> </ul>		
<b>1065NS</b> (non-sterile) <i>Custom Packs Only</i>	35 ea/cs	

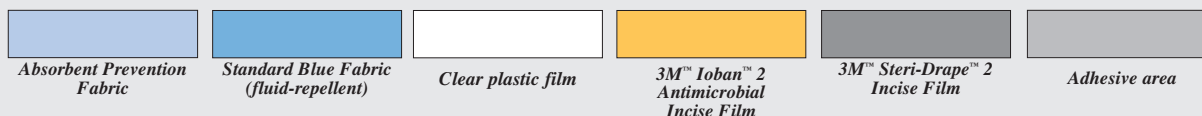

# 3M™ Steri-Drape™ GENERAL SURGERY DRAPES

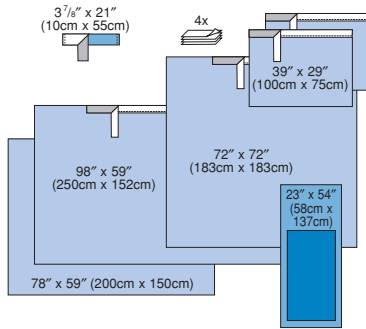

## 9000A Basic Surgical Pack

Name	Amount	Overall Size	Packs/Box	Boxes/Case
9099 OP Tape	1	3 7/8" x 21" (10cm x 55cm)	7	2
Hand Towels	4	-		
9036 Mayo Stand Cover	1	23" x 54" (58cm x 137cm)		
9086 Adhesive Towel Drapes	2	39" x 29" (100cm x 75cm)		
9087 Adhesive Drape Sheet (M)	1	72" x 72" (183cm x 183cm)		
9088 Adhesive Drape Sheet (L)	1	98" x 59" (250cm x 152cm)		
9077 Back Table Cover	1	78" x 59" (200cm x 150cm)		

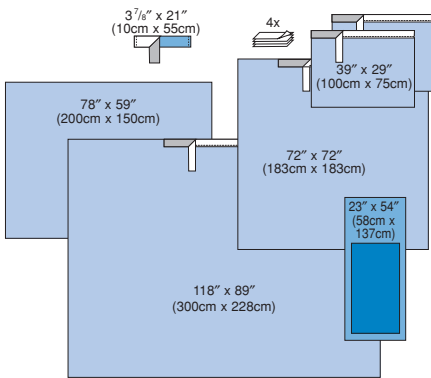

## 9000LA Basic Surgical Pack

Name	Amount	Overall Size	Packs/Box	Boxes/Case
9099 OP Tape	1	3 7/8" x 21" (10cm x 55cm)	5	2
Hand Towels	4	-		
9036 Mayo Stand Cover	1	23" x 54" (58cm x 137cm)		
9086 Adhesive Towel Drapes	2	39" x 29" (100cm x 75cm)		
9087 Adhesive Drape Sheet (M)	1	72" x 72" (183cm x 183cm)		
9090 Adhesive Drape Sheet (XL)	1	118" x 89" (300cm x 228cm)		
9077 Back Table Cover	1	78" x 59" (200cm x 150cm)		

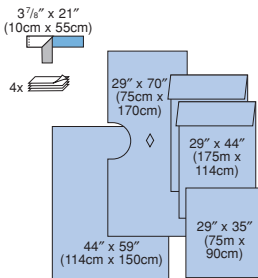

## 9003 Cystoscopy Pack

Name	Amount	Overall Size	Packs/Box	Boxes/Case
9099 OP Tape	1	3 7/8" x 21" (10cm x 55cm)	10	2
Hand Towels	4	-		
9040 Leggings (pair)	1	29" x 44" (75cm x 114cm)		
9069 Drape Sheet	1	29" x 35" (75cm x 90cm)		
Perineal Aperture Drape	1	29" x 70" (75cm x 170cm)		
9072 Back Table Cover	1	44" x 59" (114cm x 150cm)		

**KEY**

Absorbent Prevention Fabric

Standard Blue Fabric (fluid-repellent)

Clear plastic film

3M™ Ioban™ 2 Antimicrobial Incise Film

3M™ Steri-Drape™ 2 Incise Film

Adhesive area

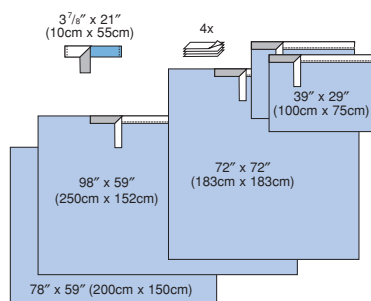

### 9010 Basic Surgical Pack without Mayo Stand Cover

Name	Amount	Overall Size	Packs/Box	Boxes/Case
9099 OP Tape	1	3 7/8" x 21" (10cm x 55cm)	7	2
Hand Towels	4	-		
9086 Adhesive Towel Drapes	2	39" x 29" (100cm x 75cm)		
9087 Adhesive Drape Sheet (M)	1	72" x 72" (183cm x 183cm)		
9088 Adhesive Drape Sheet (L)	1	98" x 59" (250cm x 152cm)		
9077 Back Table Cover	1	78" x 59" (200cm x 150cm)		

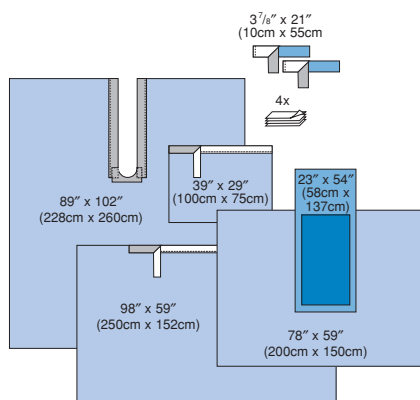

### 9018A Surgical Split Sheet Pack

Name	Amount	Overall Size	Packs/Box	Boxes/Case
9099 OP Tape	2	3 7/8" x 21" (10cm x 55cm)	6	2
Hand Towels	4	-		
9036 Mayo Stand Cover	1	23" x 54" (58cm x 137cm)		
9086 Adhesive Towel Drape	1	39" x 29" (100cm x 75cm)		
9045 Adhesive Split Sheet	1	89" x 102" (228cm x 260cm)		
9088 Adhesive Drape Sheet (L)	1	98" x 59" (250cm x 152cm)		
9077 Back Table Cover	1	78" x 59" (200cm x 150cm)		

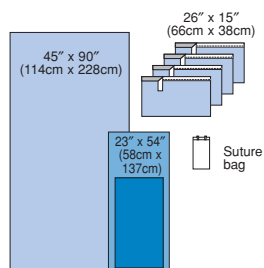

### 9020A Basic Set-Up Pack

Name	Amount	Overall Size	Packs/Box	Boxes/Case
Suture Bag	1		20	2
9036 Mayo Stand Cover	1	23" x 54" (58cm x 137cm)		
Utility Drapes	4	26" x 15" (66cm x 38cm)		
Back Table Cover	1	45" x 90" (114cm x 228cm)		

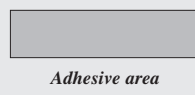
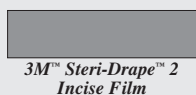
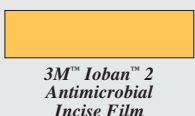
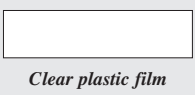
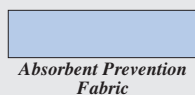

# GENERAL SURGERY DRAPES

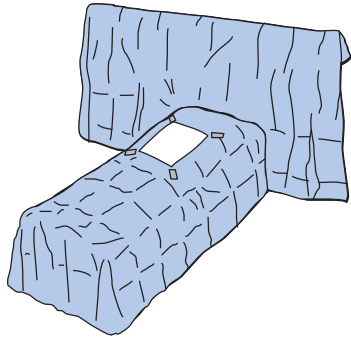

## 1031 Laparoscopy Drape - Supine Position

Overall Size	Drapes/Box	Boxes/Case
112" x 72" (285cm x 182cm)	10	2
<ul style="list-style-type: none"> <li>• Width at arm extensions: 90" (228cm)</li> <li>• Adhesive aperture: 10" x 11" (27cm x 30cm)</li> <li>• 4 – Tube organizers (ref.1115)</li> <li>• Absorbent Prevention Fabric</li> </ul>		
<b>1031NS</b> (non-sterile) <i>Custom Packs Only</i>	30 ea/cs	

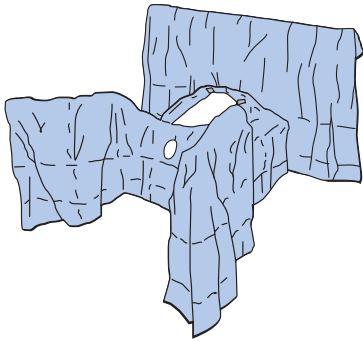

## 1032 Laparoscopy Drape - Lithotomy Position

Overall Size	Drapes/Box	Boxes/Case
95" (214cm)	8	2
<ul style="list-style-type: none"> <li>• Width at arm extensions: 89" (228cm)</li> <li>• Adhesive aperture: 10" x 11" (27cm x 30cm)</li> <li>• Peri/vag. aperture: 4<sup>5</sup>/<sub>8</sub>" x 6" (12cm x 15,5cm)</li> <li>• Leggings: 46" (117cm)</li> <li>• 4 – Tube organizers (ref.1115)</li> <li>• Absorbent Prevention Fabric</li> </ul>		
<b>1032NS</b> (non-sterile) <i>Custom Packs Only</i>	20 ea/cs	

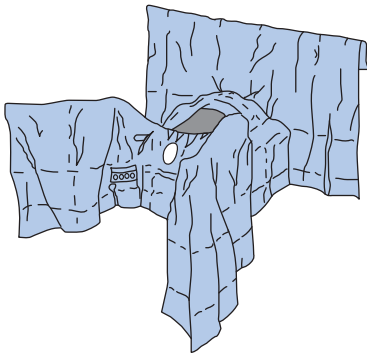

## 2065 Abdominal-Perineal Drape - Lithotomy Position

Overall Size	Drapes/Box	Boxes/Case
77" x 106" (195cm x 270cm)	8	2
<ul style="list-style-type: none"> <li>• Steri-Drape 2 incise area: 16" x 17" (41cm x 45cm)</li> <li>• Peri/vag. aperture: 4<sup>1</sup>/<sub>2</sub>" x 6" (12cm x 15,5cm)</li> <li>• Tube and cord organizers</li> <li>• Absorbent Prevention Fabric</li> </ul>		
<b>2065NS</b> (non-sterile) <i>Custom Packs Only</i>	20 ea/cs	

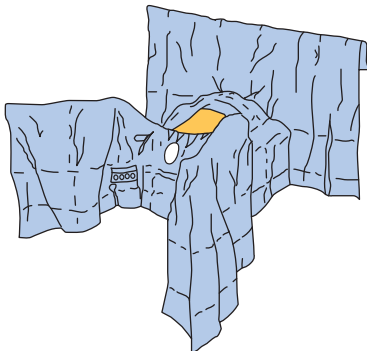

## 6665 Ioban 2 Abdominal-Perineal Drape - Lithotomy Position

Overall Size	Drapes/Box	Box/Case
78" x 106" (200cm x 270cm)	5	1
<ul style="list-style-type: none"> <li>• Ioban 2 antimicrobial incise area: 13<sup>5</sup>/<sub>8</sub>" x 18" (35cm x 46cm)</li> <li>• Peri/vag. aperture: 4<sup>5</sup>/<sub>8</sub>" x 6" (12cm x 15,5cm)</li> <li>• Tube and cord organizers</li> <li>• Absorbent Prevention Fabric</li> </ul>		

### KEY

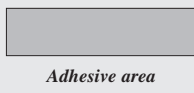
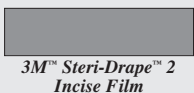
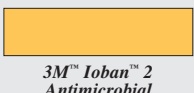
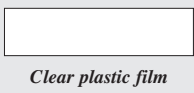
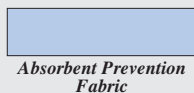

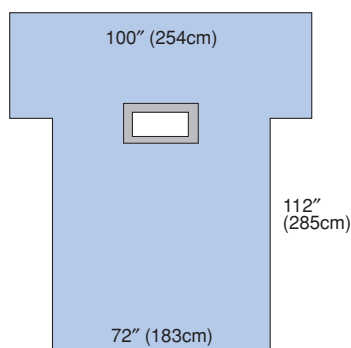

### 9062 Laparotomy Drape (transverse)

Overall Size	Drapes/Box	Boxes/Case
72" x 112" (183cm x 285cm)	12	2
<ul style="list-style-type: none"> <li>• Width at arm extensions: 100" (254cm)</li> <li>• Adhesive aperture: 12" x 4" (30cm x 10cm)</li> <li>• Absorbent Prevention Fabric</li> </ul>		
<b>9062NS</b> (non-sterile) <i>Custom Packs Only</i>	26 ea/cs	

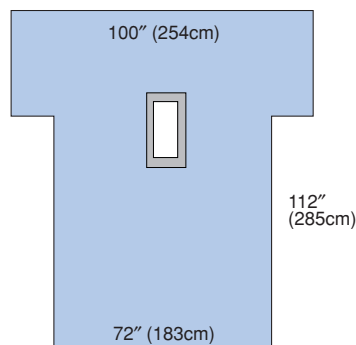

### 9063 Laparotomy Drape

Overall Size	Drapes/Box	Boxes/Case
72" x 112" (183cm x 285cm)	10	2
<ul style="list-style-type: none"> <li>• Width at arm extensions: 100" (254cm)</li> <li>• Adhesive aperture: 3 7/8" x 12" (10cm x 30cm)</li> <li>• Absorbent Prevention Fabric</li> </ul>		
<b>9063NS</b> (non-sterile) <i>Custom Packs Only</i>	24 ea/cs	

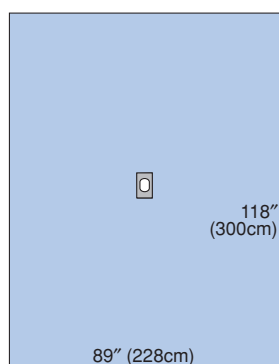

### 9050 Adhesive Aperture Drape

Overall Size	Drapes/Box	Boxes/Case
89" x 118" (228cm x 300cm)	10	2
<ul style="list-style-type: none"> <li>• Adhesive aperture: 4 5/8" x 6 1/4" (12cm x 16cm)</li> <li>• Absorbent Prevention Fabric</li> </ul>		
<b>9050NS</b> (non-sterile) <i>Custom Packs Only</i>	30 ea/cs	



# 3M™ Steri-Drape™

## GENERAL SURGERY DRAPES

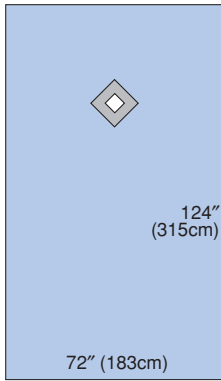

### 9051 Thyroid Drape

Overall Size	Drapes/Box	Boxes/Case
72" x 124" (183cm x 315cm)	15	2

- Adhesive diamond aperture: 4<sup>4</sup>/<sub>8</sub>" x 4<sup>5</sup>/<sub>8</sub>" (12cm x 12cm)

- Absorbent Prevention Fabric

<b>9051NS</b> (non-sterile) <i>Custom Packs Only</i>	34 ea/cs
--	----------

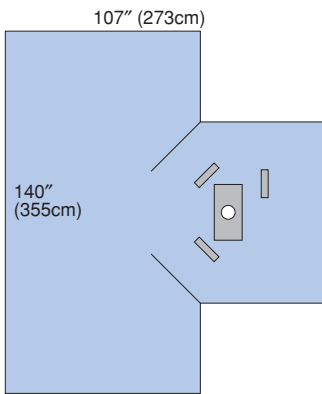

### 9052 Hand Drape

Overall Size	Drapes/Box	Boxes/Case
140" x 107" (355cm x 273cm)	9	2

- Elastic circle aperture: 1" (3cm)

- 3 – Tube and cord organizers

- Absorbent Prevention Fabric

<b>9052NS</b> (non-sterile) <i>Custom Packs Only</i>	20 ea/cs
--	----------

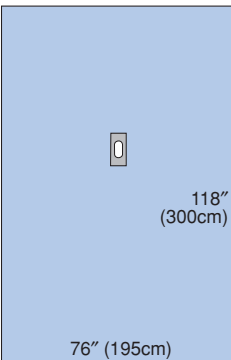

### 9054 Hand and Foot Drape

Overall Size	Drapes/Box	Boxes/Case
76" x 118" (195cm x 300cm)	12	2

- Elastic aperture: 1" (3cm)

- Absorbent Prevention Fabric

<b>9054NS</b> (non-sterile) <i>Custom Packs Only</i>	30 ea/cs
--	----------

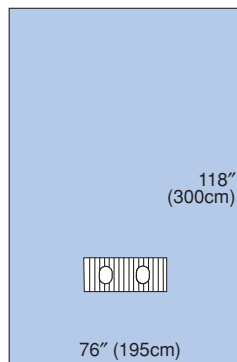

### 9056 Bilateral Foot Drape

Overall Size	Drapes/Box	Boxes/Case
76" x 118" (195cm x 300cm)	13	2

- Elastic apertures: 1<sup>1</sup>/<sub>2</sub>" (4cm)

- Absorbent Prevention Fabric

<b>9056NS</b> (non-sterile) <i>Custom Packs Only</i>	28 ea/cs
--	----------

General Surgery Drapes

## KEY

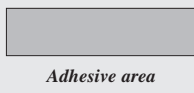
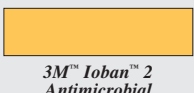
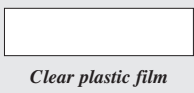
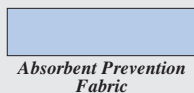



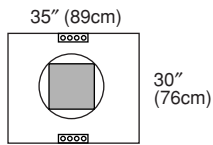

### 2057 Incise Pouch

Overall Size	Drapes/Box	Boxes/Case
35" x 30" (89cm x 76cm)	10	4
<ul style="list-style-type: none"> <li>• Incise area: 12" x 12" (30cm x 30cm)</li> <li>• 360-degree fluid collection pouch</li> <li>• Tube and cord organizers</li> </ul>		
<b>2057NS</b> (non-sterile) <i>Custom Packs Only</i>	100 ea/cs	

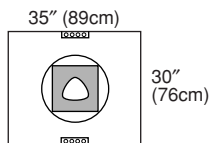

### 2058 Aperture Pouch

Overall Size	Drapes/Box	Boxes/Case
35" x 30" (89cm x 76cm)	10	4
<ul style="list-style-type: none"> <li>• Aperture incise area: 12" x 12" (30cm x 30cm)</li> <li>• 360-degree fluid collection pouch</li> <li>• Tube and cord organizers</li> </ul>		
<b>2058NS</b> (non-sterile) <i>Custom Packs Only</i>	100 ea/cs	

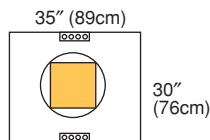

### 6657 Pouch with Ioban 2 Incise Film

Overall Size	Drapes/Box	Boxes/Case
35" x 30" (89cm x 76cm)	10	4
<ul style="list-style-type: none"> <li>• Ioban 2 antimicrobial incise area: 12" x 12" (30cm x 30cm)</li> <li>• 360-degree fluid collection pouch</li> <li>• Tube and cord organizers</li> </ul>		

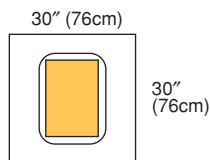

### 6658 Pouch with Ioban 2 Incise Film, Large

Overall Size	Drapes/Box	Boxes/Case
30" x 30" (76cm x 76cm)	5	4
<ul style="list-style-type: none"> <li>• Ioban 2 antimicrobial incise area: 13" x 17" (33cm x 43cm)</li> <li>• 360-degree fluid collection pouch</li> </ul>		

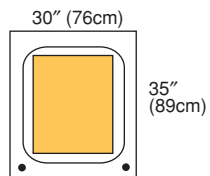

### 6659 Pouch with Ioban 2 Incise Film, Extra Large

Overall Size	Drapes/Box	Boxes/Case
30" x 35" (76cm x 89cm)	5	4
<ul style="list-style-type: none"> <li>• Ioban 2 antimicrobial incise area: 16" x 20" (42cm x 52cm)</li> <li>• 360-degree fluid collection pouch</li> <li>• 2 – Exit ports</li> </ul>		

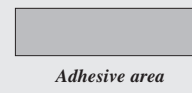
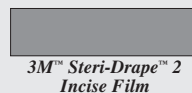
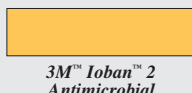
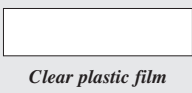
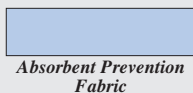

# GENERAL SURGERY DRAPES

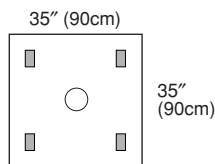

## 1073 Wound Edge Protector

Overall Size	Drapes/Box	Boxes/Case
35" x 35" (90cm x 90cm)	10	4
<ul style="list-style-type: none"> <li>• Ring diameter: 4<sup>3</sup>/<sub>4</sub>" (12cm)</li> <li>• 4 – Adhesive patches</li> </ul>		

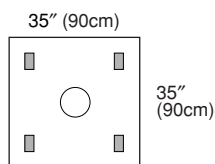

## 1074 Wound Edge Protector

Overall Size	Drapes/Box	Boxes/Case
35" x 35" (90cm x 90cm)	10	4
<ul style="list-style-type: none"> <li>• Ring diameter: 6<sup>5</sup>/<sub>8</sub>" (17cm)</li> <li>• 4 – Adhesive patches</li> </ul>		

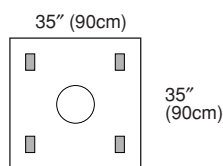

## 1075 Wound Edge Protector

Overall Size	Drapes/Box	Boxes/Case
35" x 35" (90cm x 90cm)	10	4
<ul style="list-style-type: none"> <li>• Ring diameter: 8<sup>5</sup>/<sub>8</sub>" (22cm)</li> <li>• 4 – Adhesive patches</li> </ul>		

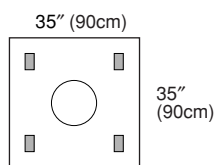

## 1076 Wound Edge Protector

Overall Size	Drapes/Box	Boxes/Case
35" x 35" (90cm x 90cm)	10	4
<ul style="list-style-type: none"> <li>• Ring diameter: 10" (27cm)</li> <li>• 4 – Adhesive patches</li> </ul>		

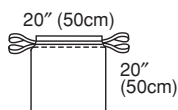

## 1003 Isolation Bag

Overall Size	Drapes/Box	Boxes/Case
20" x 20" (50cm x 50cm)	10	4
<ul style="list-style-type: none"> <li>• Drawstring closure</li> </ul>		
<b>1003NS</b> (non-sterile) <i>Custom Packs Only</i>	200 ea/cs	

### KEY

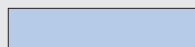
 Absorbent Prevention Fabric

 Standard Blue Fabric (fluid-repellent)

 Clear plastic film

 3M™ Ioban™ 2 Antimicrobial Incise Film

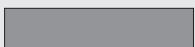
 3M™ Steri-Drape™ 2 Incise Film

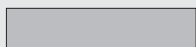
 Adhesive area

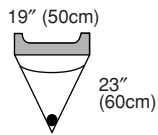

### 1016 Irrigation Pouch

Overall Size	Drapes/Box	Boxes/Case
19" x 23" (50cm x 60cm)	10	4
<ul style="list-style-type: none"> <li>• Adhesive strip</li> <li>• 1 – Exit port</li> <li>• Screen</li> </ul>		
<b>1016NS</b> (non-sterile) <i>Custom Packs Only</i>	200 ea/cs	

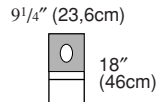

### 1072 Aperture Pouch Drape

Overall Size	Packs/Box	Boxes/Case
9 1/4" x 18" (23,6cm x 46cm)	10	4
<ul style="list-style-type: none"> <li>• Adhesive area: 9 1/4" x 10" (23,6cm x 26cm)</li> <li>• Oval aperture: 3 1/2" x 4 1/4" (9,2cm x 11,6cm)</li> <li>• Fluid collection pouch</li> </ul>		
<b>1072NS</b> (non-sterile) <i>Custom Packs Only</i>	200 ea/cs	

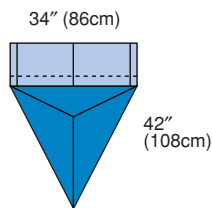

### 1084 Under Buttocks Drape with Pouch

Overall Size	Drapes/Box	Box/Case
34" x 42" (86cm x 108cm)	30	4
<ul style="list-style-type: none"> <li>• Cuff size: 10" (27cm)</li> <li>• Fluid collection pouch</li> <li>• Absorbent Prevention Fabric</li> </ul>		
<b>1084NS</b> (non-sterile) <i>Custom Packs Only</i>	140 ea/cs	

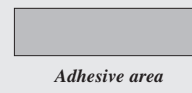
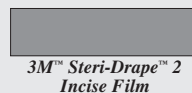
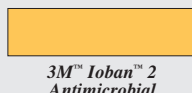
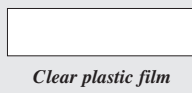
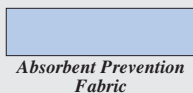

# 3M™ Steri-Drape™ UROLOGY DRAPES

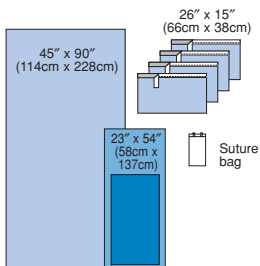
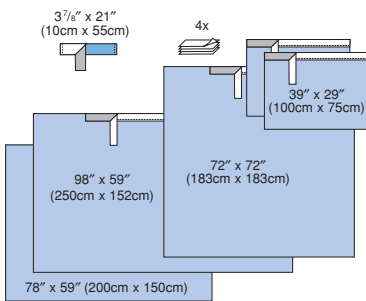
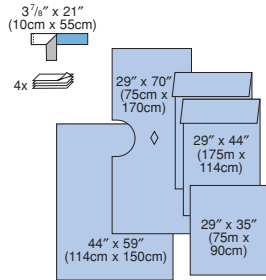
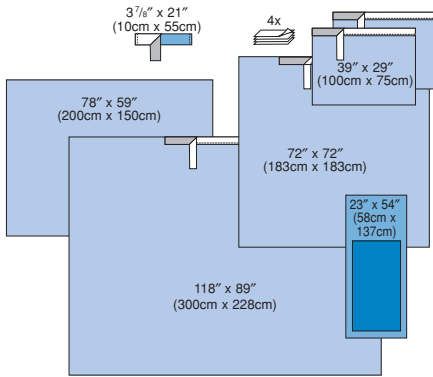
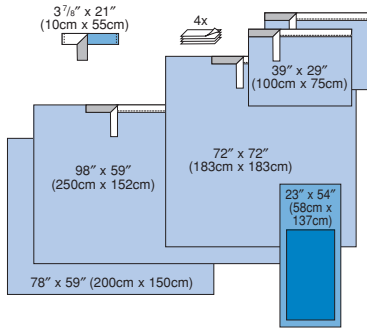

## 9000A Basic Surgical Pack

Name	Amount	Overall Size	Packs/Box	Boxes/Case
9099 OP Tape	1	3 7/8" x 21" (10cm x 55cm)	7	2
Hand Towels	4	-		
9036 Mayo Stand Cover	1	23" x 54" (58cm x 137cm)		
9086 Adhesive Towel Drapes	2	39" x 29" (100cm x 75cm)		
9087 Adhesive Drape Sheet (M)	1	72" x 72" (183cm x 183cm)		
9088 Adhesive Drape Sheet (L)	1	98" x 59" (250cm x 152cm)		
9077 Back Table Cover	1	78" x 59" (200cm x 150cm)		

## 9000LA Basic Surgical Pack

Name	Amount	Overall Size	Packs/Box	Boxes/Case
9099 OP Tape	1	3 7/8" x 21" (10cm x 55cm)	5	2
Hand Towels	4	-		
9036 Mayo Stand Cover	1	23" x 54" (58cm x 137cm)		
9086 Adhesive Towel Drapes	2	39" x 29" (100cm x 75cm)		
9087 Adhesive Drape Sheet (M)	1	72" x 72" (183cm x 183cm)		
9090 Adhesive Drape Sheet (XL)	1	118" x 89" (300cm x 228cm)		
9077 Back Table Cover	1	78" x 59" (200cm x 150cm)		

## 9003 Cystoscopy Pack

Name	Amount	Overall Size	Packs/Box	Boxes/Case
9099 OP Tape	1	3 7/8" x 21" (10cm x 55cm)	10	2
Hand Towels	4	-		
9040 Leggings (pair)	1	29" x 44" (75cm x 114cm)		
9069 Drape Sheet	1	29" x 35" (75cm x 90cm)		
Perineal Aperture Drape	1	29" x 70" (75cm x 170cm)		
9072 Back Table Cover	1	44" x 59" (114cm x 150cm)		

## 9010 Basic Surgical Pack without Mayo Stand Cover

Name	Amount	Overall Size	Packs/Box	Boxes/Case
9099 OP Tape	1	3 7/8" x 21" (10cm x 55cm)	7	2
Hand Towels	4	-		
9086 Adhesive Towel Drapes	2	39" x 29" (100cm x 75cm)		
9087 Adhesive Drape Sheet (M)	1	72" x 72" (183cm x 183cm)		
9088 Adhesive Drape Sheet (L)	1	98" x 59" (250cm x 152cm)		
9077 Back Table Cover	1	78" x 59" (200cm x 150cm)		

## 9020A Basic Set-Up Pack

Name	Amount	Overall Size	Packs/Box	Boxes/Case
Suture Bag	1		20	2
9036 Mayo Stand Cover	1	23" x 54" (58cm x 137cm)		
Utility Drapes	4	26" x 15" (66cm x 38cm)		
Back Table Cover	1	45" x 90" (114cm x 228cm)		

**KEY**

Absorbent Prevention Fabric

Standard Blue Fabric (fluid-repellent)

Clear plastic film

3M™ Ioban™ 2 Antimicrobial Incise Film

3M™ Steri-Drape™ 2 Incise Film

Adhesive area

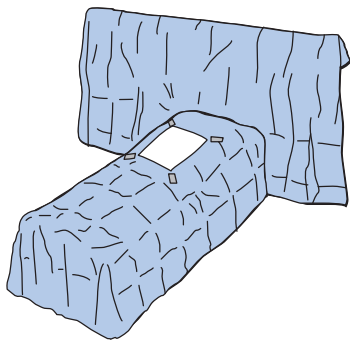

### 1031 Laparoscopy Drape - Supine Position

Overall Size	Drapes/Box	Boxes/Case
112" x 72" (285cm x 182cm)	10	2
<ul style="list-style-type: none"> <li>• Width at arm extensions: 90" (228cm)</li> <li>• Adhesive aperture: 10" x 11" (27cm x 30cm)</li> <li>• 4 – Tube organizers (ref.1115)</li> <li>• Absorbent Prevention Fabric</li> </ul>		
<b>1031NS</b> (non-sterile) <i>Custom Packs Only</i>	30 ea/cs	

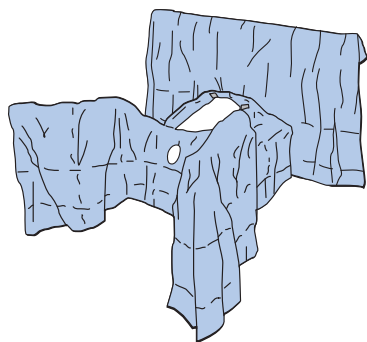

### 1032 Laparoscopy Drape - Lithotomy Position

Overall Size	Drapes/Box	Boxes/Case
95" (214cm)	8	2
<ul style="list-style-type: none"> <li>• Width at arm extensions: 89" (228cm)</li> <li>• Adhesive aperture: 10" x 11" (27cm x 30cm)</li> <li>• Peri/vag. aperture: 4.5/8" x 6" (12cm x 15,5cm)</li> <li>• Leggings: 46" (117cm)</li> <li>• 4 – Tube organizers (ref.1115)</li> <li>• Absorbent Prevention Fabric</li> </ul>		
<b>1032NS</b> (non-sterile) <i>Custom Packs Only</i>	20 ea/cs	



### 2065 Abdominal-Perineal Drape - Lithotomy Position

Overall Size	Drapes/Box	Boxes/Case
77" x 160" (195cm x 270cm)	8	2
<ul style="list-style-type: none"> <li>• Steri-Drape 2 incise area: 16" x 17" (41cm x 45cm)</li> <li>• Peri/vag. aperture: 4 1/2" x 6" (12cm x 15,5cm)</li> <li>• Tube and cord organizers</li> <li>• Absorbent Prevention Fabric</li> </ul>		
<b>2065NS</b> (non-sterile) <i>Custom Packs Only</i>	20 ea/cs	

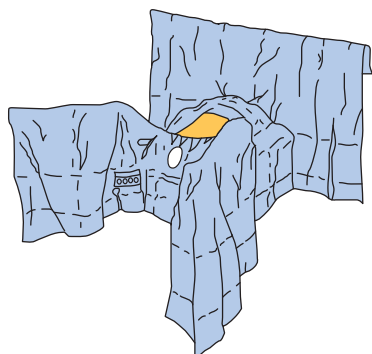

### 6665 Ioban 2 Abdominal-Perineal Drape - Lithotomy Position

Overall Size	Drapes/Box	Box/Case
78" x 106" (200cm x 270cm)	5	1
<ul style="list-style-type: none"> <li>• Ioban 2 antimicrobial incise area: 13 5/8" x 18" (35cm x 46cm)</li> <li>• Peri/vag. aperture: 4.5/8" x 6" (12cm x 15,5cm)</li> <li>• Tube and cord organizers</li> <li>• Absorbent Prevention Fabric</li> </ul>		

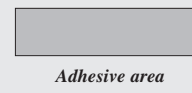
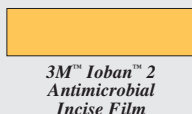
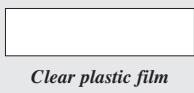
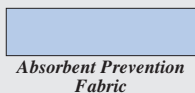

# 3M™ Steri-Drape™ UROLOGY DRAPES

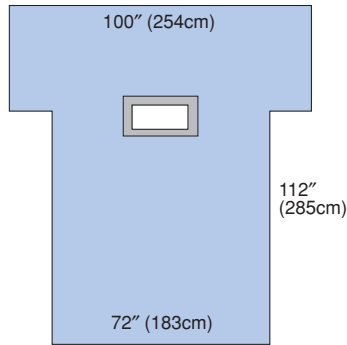

## 9062 Laparotomy Drape (transverse)

Overall Size	Drapes/Box	Boxes/Case
72" x 112" (183cm x 285cm)	12	2
<ul style="list-style-type: none"> <li>• Width at arm extensions: 100" (254cm)</li> <li>• Aperture: 12" x 4" (30cm x 10cm)</li> <li>• Absorbent Prevention Fabric</li> </ul>		
<b>9062NS</b> (non-sterile) <i>Custom Packs Only</i>	26 ea/cs	

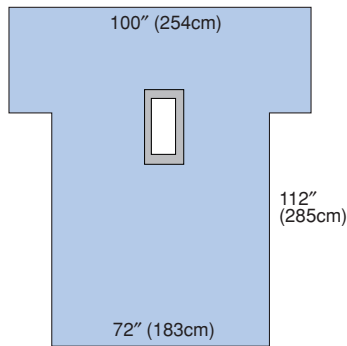

## 9063 Laparotomy Drape

Overall Size	Drapes/Box	Boxes/Case
72" x 112" (183cm x 285cm)	10	2
<ul style="list-style-type: none"> <li>• Width at arm extensions: 100" (254cm)</li> <li>• Aperture: 3 7/8" x 12" (10cm x 30cm)</li> <li>• Absorbent Prevention Fabric</li> </ul>		
<b>9063NS</b> (non-sterile) <i>Custom Packs Only</i>	24 ea/cs	

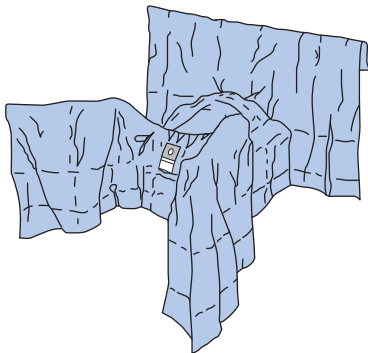

## 1080 Gynaecology Drape with Pouch

Overall Size	Drapes/Box	Boxes/Case
77" x 70" (195cm x 179cm)	14	2
<ul style="list-style-type: none"> <li>• Peri/vag. aperture: 3 1/2" x 4 1/2" (9cm x 11cm)</li> <li>• Tube and cord organizers</li> <li>• Fluid collection pouch (ref. 1072)</li> <li>• Absorbent Prevention Fabric</li> </ul>		
<b>1080NS</b> (non-sterile) <i>Custom Packs Only</i>	30 ea/cs	

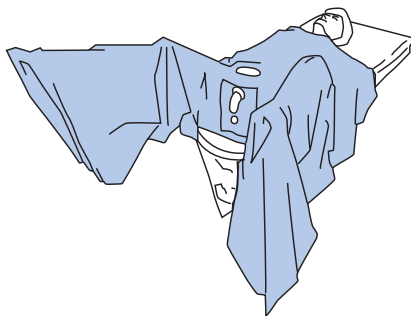

## 1081 TUR/Urological Drape

Overall Size	Drapes/Box	Boxes/Case
Length: 64" (164cm)	14	2
<ul style="list-style-type: none"> <li>• Width at arm extensions: 60" (152cm)</li> <li>• Abdominal adhesive aperture: 2" (6cm)</li> <li>• Elastic aperture</li> <li>• Non-latex finger cot</li> <li>• Large integrated fluid collection pouch with filter and exit ports</li> <li>• Absorbent Prevention Fabric</li> </ul>		
<b>1081NS</b> (non-sterile) <i>Custom Packs Only</i>	30 ea/cs	

### KEY

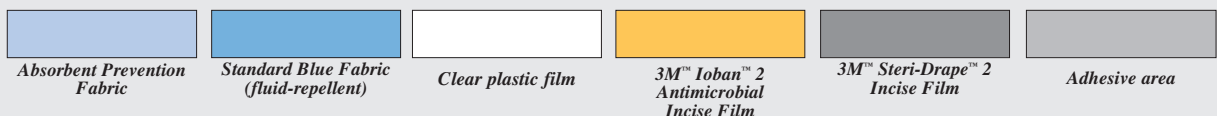

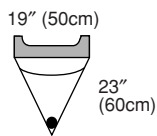

### 1016 Irrigation Pouch

Overall Size	Drapes/Box	Boxes/Case
19" x 23" (50cm x 60cm)	10	4
<ul style="list-style-type: none"> <li>• Adhesive strip</li> <li>• 1 – Exit port</li> <li>• Screen</li> </ul>		
<b>1016NS</b> (non-sterile) <i>Custom Packs Only</i>	200 ea/cs	

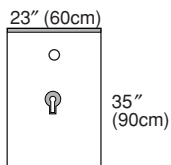

### 1071 Urological Sheet

Overall Size	Drapes/Box	Boxes/Case
23" x 35" (60cm x 90cm)	10	4
<ul style="list-style-type: none"> <li>• Aperture area: 2" (5,2cm)</li> <li>• Non-latex finger cot with adhesive</li> <li>• Adhesive strip</li> </ul>		
<b>1071NS</b> (non-sterile) <i>Custom Packs Only</i>	200 ea/cs	

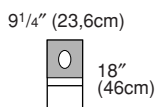

### 1072 Aperture Pouch Drape

Overall Size	Packs/Box	Boxes/Case
9 1/4" x 18" (23,6cm x 46cm)	10	4
<ul style="list-style-type: none"> <li>• Adhesive area: 9 1/4" x 10" (23,6cm x 26cm)</li> <li>• Oval aperture: 3 1/2" x 4 1/4" (9,2cm x 11,6cm)</li> <li>• Fluid collection pouch</li> </ul>		
<b>1072NS</b> (non-sterile) <i>Custom Packs Only</i>	200 ea/cs	

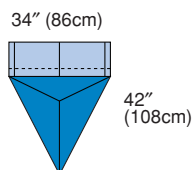

### 1084 Under Buttocks Drape with Pouch

Overall Size	Drapes/Box	Box/Case
34" x 42" (86cm x 108cm)	30	4
<ul style="list-style-type: none"> <li>• Cuff size: 10" (27cm)</li> <li>• Fluid collection pouch</li> <li>• Absorbent Prevention Fabric</li> </ul>		
<b>1084NS</b> (non-sterile) <i>Custom Packs Only</i>	140 ea/cs	

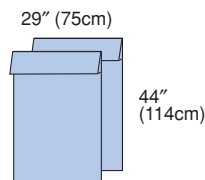

### 9040 Leggings (pair)

Overall Size	Drapes/Box	Boxes/Case
29" x 44" (75cm x 114cm)	10	4
<ul style="list-style-type: none"> <li>• Absorbent Prevention Fabric</li> </ul>		
<b>9040NS</b> (non-sterile) <i>Custom Packs Only</i>	116 ea/cs	

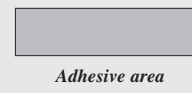
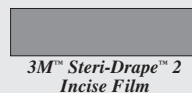
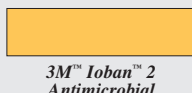
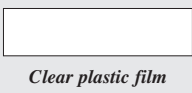
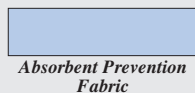

# 3M™ Steri-Drape™ NEUROLOGY DRAPES

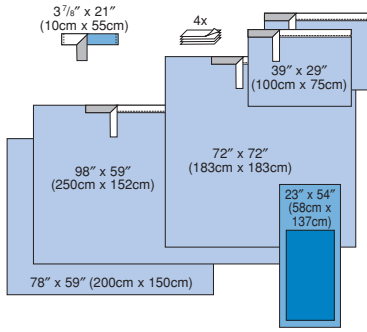

## 9000A Basic Surgical Pack

Name	Amount	Overall Size	Packs/Box	Boxes/Case
9099 OP Tape	1	3 7/8" x 21" (10cm x 55cm)	7	2
Hand Towels	4	-		
9036 Mayo Stand Cover	1	23" x 54" (58cm x 137cm)		
9086 Adhesive Towel Drapes	2	39" x 29" (100cm x 75cm)		
9087 Adhesive Drape Sheet (M)	1	72" x 72" (183cm x 183cm)		
9088 Adhesive Drape Sheet (L)	1	98" x 59" (250cm x 152cm)		
9077 Back Table Cover	1	78" x 59" (200cm x 150cm)		

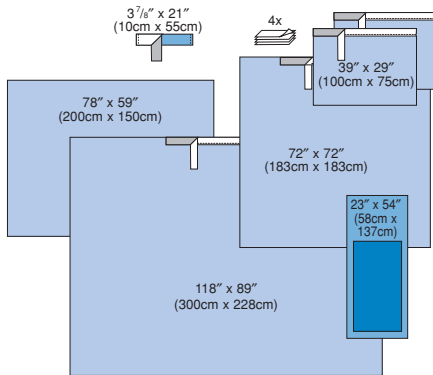

## 9000LA Basic Surgical Pack

Name	Amount	Overall Size	Packs/Box	Boxes/Case
9099 OP Tape	1	3 7/8" x 21" (10cm x 55cm)	5	2
Hand Towels	4	-		
9036 Mayo Stand Cover	1	23" x 54" (58cm x 137cm)		
9086 Adhesive Towel Drapes	2	39" x 29" (100cm x 75cm)		
9087 Adhesive Drape Sheet (M)	1	72" x 72" (183cm x 183cm)		
9090 Adhesive Drape Sheet (XL)	1	118" x 89" (300cm x 228cm)		
9077 Back Table Cover	1	78" x 59" (200cm x 150cm)		

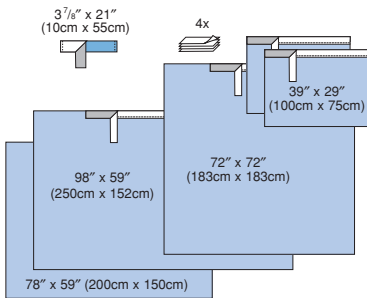

## 9010 Basic Surgical Pack without Mayo Stand Cover

Name	Amount	Overall Size	Packs/Box	Boxes/Case
9099 OP Tape	1	3 7/8" x 21" (10cm x 55cm)	7	2
Hand Towels	4	-		
9086 Adhesive Towel Drapes	2	39" x 29" (100cm x 75cm)		
9087 Adhesive Drape Sheet (M)	1	72" x 72" (183cm x 183cm)		
9088 Adhesive Drape Sheet (L)	1	98" x 59" (250cm x 152cm)		
9077 Back Table Cover	1	78" x 59" (200cm x 150cm)		

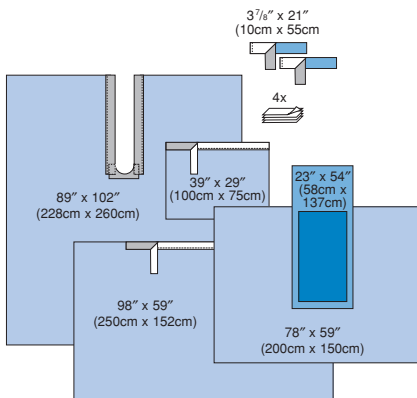

## 9018A Surgical Split Sheet Pack

Name	Amount	Overall Size	Packs/Box	Boxes/Case
9099 OP Tape	2	3 7/8" x 21" (10cm x 55cm)	6	2
Hand Towels	4	-		
9036 Mayo Stand Cover	1	23" x 54" (58cm x 137cm)		
9086 Adhesive Towel Drape	1	39" x 29" (100cm x 75cm)		
9045 Adhesive Split Sheet	1	89" x 102" (228cm x 260cm)		
9088 Adhesive Drape Sheet (L)	1	98" x 59" (250cm x 152cm)		
9077 Back Table Cover	1	78" x 59" (200cm x 150cm)		

**KEY**

Absorbent Prevention Fabric

Standard Blue Fabric (fluid-repellent)

Clear plastic film

3M™ Ioban™ 2 Antimicrobial Incise Film

3M™ Steri-Drape™ 2 Incise Film

Adhesive area



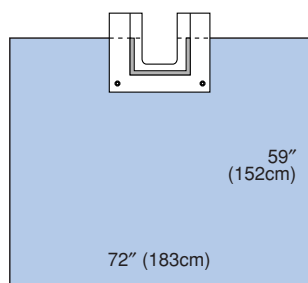

### 9047 Neuro Split Sheet with Pouch

Overall Size	Drapes/Box	Boxes/Case
72" x 59" (183cm x 152cm)	15	2
<ul style="list-style-type: none"> <li>• Adhesive split: 6" x 15" (16cm x 40cm)</li> <li>• Fluid collection pouch (ref. 1067)</li> <li>• 2 – Exit ports</li> <li>• Absorbent Prevention Fabric</li> </ul>		
<b>9047NS</b> (non-sterile) <i>Custom Packs Only</i>	32 ea/cs	

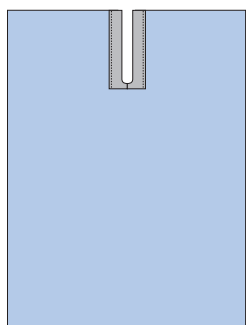

### 9048 Adhesive Split Sheet

Overall Size	Drapes/Box	Boxes/Case
90" x 102" (228cm x 260cm)	15	2
<ul style="list-style-type: none"> <li>• Adhesive split: 7" x 15" (20cm x 40)</li> <li>• Absorbent Prevention Fabric</li> </ul>		
<b>9048NS</b> (non-sterile) <i>Custom Packs Only</i>	32 ea/cs	

90" (228cm)

77" (196cm)

102"  
(260cm)

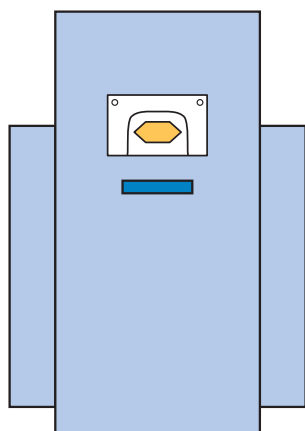

### 6687 Craniotomy Drape

Overall Size	Drapes/Box	Boxes/Case
77" x 170" (196cm x 432cm)	10	1
<ul style="list-style-type: none"> <li>• Incise area: 14.5" x 8.43" (36.8cm x 21.4cm)</li> <li>• Large rectangular fluid collection pouch</li> <li>• Adhesive secural on skull flap</li> <li>• Absorbent Prevention Fabric</li> </ul>		

170"  
(196cm)

### Adhesive Split Sheets

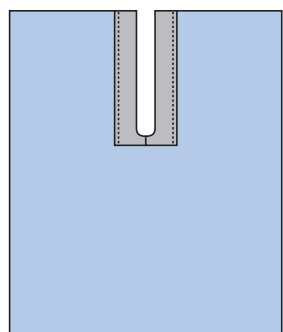

	Overall Size	Drapes/Box	Boxes/Case
<i>Split size 2 1/2" x 27" (7cm x 70cm)</i>			
<b>9043</b>	59" x 72" (152cm x 183cm)	30	2
<b>9044</b>	59" x 98" (152cm x 250cm)	25	2
<i>Split size 7 3/4" x 39" (20cm x 100cm)</i>			
<b>9045</b>	89" x 102" (228cm x 260cm)	15	2
• Absorbent Prevention Fabric			
<b>9043NS</b> (non-sterile) <i>Custom Packs Only</i>		68 ea/cs	
<b>9044NS</b> (non-sterile) <i>Custom Packs Only</i>		58 ea/cs	
<b>9045NS</b> (non-sterile) <i>Custom Packs Only</i>		30 ea/cs	

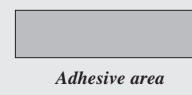
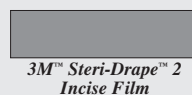
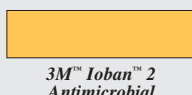
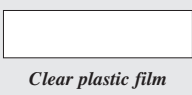
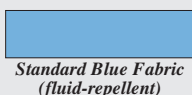
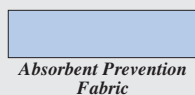

# 3M™ Steri-Drape™ NEUROLOGY DRAPES

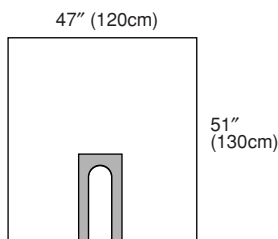

## 1015 U-drape

Overall Size	Drapes/Box	Boxes/Case
47" x 51" (120cm x 130cm)	10	4
• Adhesive split: 6 1/2" x 18" (16,5cm x 46cm)		
<b>1015NSD</b> (non-sterile)	100 ea/cs	
<b>1015NS</b> (non-sterile) <i>Custom Packs Only</i>	200 ea/cs	

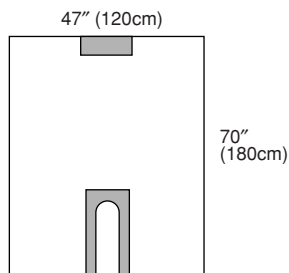

## 1019 Long U-drape

Overall Size	Drapes/Box	Boxes/Case
47" x 70" (120cm x 180cm)	10	4
• Adhesive split: 6 1/2" x 18" (16,5cm x 46cm)		
• Adhesive patch		
<b>1019NS</b> (non-sterile) <i>Custom Packs Only</i>	200 ea/cs	

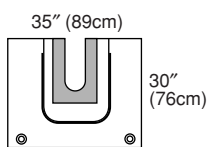

## 1067 U-pouch

Overall Size	Drapes/Box	Boxes/Case
35" x 30" (89cm x 76cm)	5	4
• Adhesive split: 6" x 15" (16cm x 40cm)		
• Fluid collection pouch		
• 2 – Exit ports		
<b>1067NS</b> (non-sterile) <i>Custom Packs Only</i>	50 ea/cs	

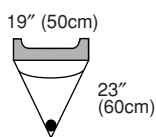

## 1016 Irrigation Pouch

Overall Size	Drapes/Box	Boxes/Case
19" x 23" (50cm x 60cm)	10	4
• Adhesive strip		
• 1 – Exit port		
• Screen		
<b>1016NS</b> (non-sterile) <i>Custom Packs Only</i>	200 ea/cs	

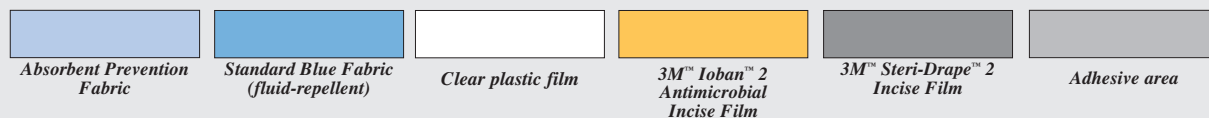

# SURGICAL SHEETS AND ACCESSORIES

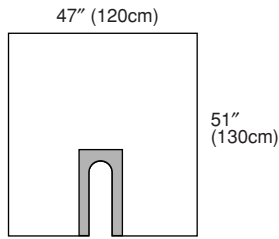

## 1015 U-drape

Overall Size	Drapes/Box	Boxes/Case
47" x 51" (120cm x 130cm)	10	4
<ul style="list-style-type: none"> <li>• Adhesive split: 6 1/2" x 18" (16,5cm x 46cm)</li> <li>• Clear plastic</li> </ul>		
<b>1015NSD</b> (non-sterile)	100	1
<b>1015NS</b> (non-sterile) <i>Custom Packs Only</i>	200 ea/cs	

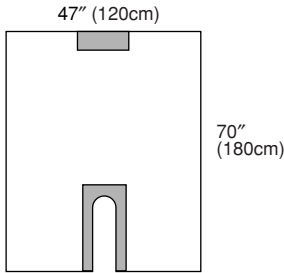

## 1019 Long U-drape

Overall Size	Drapes/Box	Boxes/Case
47" x 70" (120cm x 180cm)	10	4
<ul style="list-style-type: none"> <li>• Adhesive split: 6 1/2" x 18" (16,5cm x 46cm)</li> <li>• Adhesive patch</li> </ul>		
<b>1019NS</b> (non-sterile) <i>Custom Packs Only</i>	200 ea/cs	

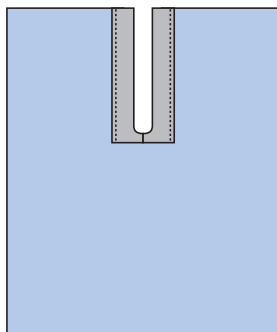

## Adhesive Split Sheets

	Overall Size	Drapes/Box	Boxes/Case
<i>Split size 2 1/2" x 27" (7cm x 70cm)</i>			
<b>9043</b>	59" x 72" (152cm x 183cm)	30	2
<b>9044</b>	59" x 98" (152cm x 250cm)	25	2
<i>Split size 7 3/4" x 39" (20cm x 100cm)</i>			
<b>9045</b>	89" x 102" (228cm x 260cm)	15	2
• Absorbent Prevention Fabric			
<b>9043NS</b> (non-sterile) <i>Custom Packs Only</i>		68 ea/cs	
<b>9044NS</b> (non-sterile) <i>Custom Packs Only</i>		58 ea/cs	
<b>9045NS</b> (non-sterile) <i>Custom Packs Only</i>		30 ea/cs	

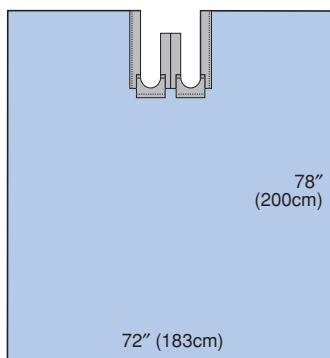

## 9046 Bilateral Split Sheet

Overall Size	Drapes/Box	Boxes/Case
72" x 78" (183cm x 200cm)	15	2
<ul style="list-style-type: none"> <li>• Double adhesive split: 5 7/8" x 19" (15cm x 50cm)</li> <li>• Absorbent Prevention Fabric</li> </ul>		
<b>9046NS</b> (non-sterile) <i>Custom Packs Only</i>	30 ea/cs	

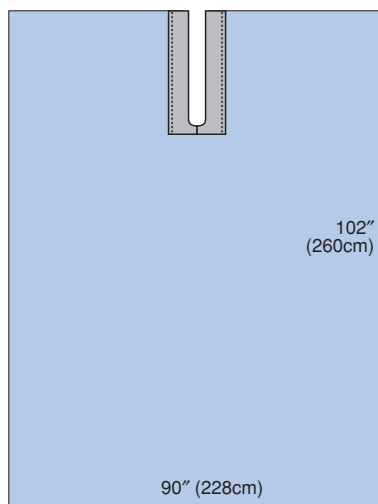

### 9048 Adhesive Split Sheet

Overall Size	Drapes/Box	Boxes/Case
90" x 102" (228cm x 260cm)	15	2
<ul style="list-style-type: none"> <li>• Adhesive split: 7<sup>3</sup>/<sub>4</sub>" x 15" (20cm x 40)</li> <li>• Absorbent Prevention Fabric</li> </ul>		
<b>9048NS</b> (non-sterile) <i>Custom Packs Only</i>	32 ea/cs	

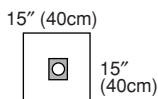

### 1020 Small Drape with Adhesive Aperture

Overall Size	Drapes/Box	Boxes/Case
15" x 15" (40cm x 40cm)	10	4
<ul style="list-style-type: none"> <li>• Adhesive area: 3<sup>7</sup>/<sub>8</sub>" x 4<sup>7</sup>/<sub>8</sub>" (10cm x 12,5cm)</li> <li>• Circle aperture: 2<sup>3</sup>/<sub>8</sub>" (6,3cm)</li> </ul>		
<b>1020NS</b> (non-sterile) <i>Custom Packs Only</i>	200 ea/cs	

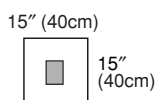

### 1021 Small Drape with Incise Film

Overall Size	Drapes/Box	Boxes/Case
15" x 15" (40cm x 40cm)	10	4
<ul style="list-style-type: none"> <li>• Incise area: 3<sup>7</sup>/<sub>8</sub>" x 4<sup>7</sup>/<sub>8</sub>" (10cm x 12,5cm)</li> </ul>		
<b>1021NS</b> (non-sterile) <i>Custom Packs Only</i>	200 ea/cs	

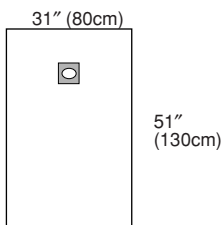

### 1030 Medium Drape with Adhesive Aperture

Overall Size	Drapes/Box	Boxes/Case
31" x 51" (80cm x 130cm)	10	4
<ul style="list-style-type: none"> <li>• Adhesive area: 3<sup>7</sup>/<sub>8</sub>" x 4<sup>7</sup>/<sub>8</sub>" (10cm x 12,5cm)</li> <li>• Oval aperture: 2" x 2<sup>7</sup>/<sub>8</sub>" (5,2cm x 7,6cm)</li> </ul>		
<b>1030NS</b> (non-sterile) <i>Custom Packs Only</i>	200 ea/cs	

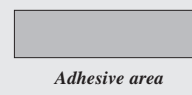
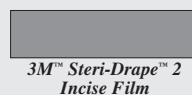
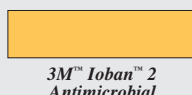
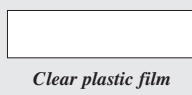
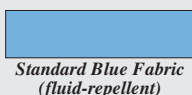
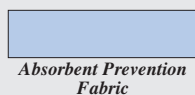

# SURGICAL SHEETS AND ACCESSORIES

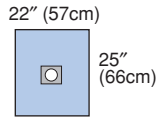

## 1092 Small Drape with Adhesive Aperture

Overall Size	Drapes/Box	Boxes/Case
22" x 25" (57cm x 66cm)	25	4
Adhesive area: 3 7/8" x 3 7/8" (10cm x 10cm)		
Circle aperture: 2 3/8" (6,3cm)		
• Absorbent Prevention Fabric		
<b>1092NS</b> (non-sterile) <i>Custom Packs Only</i>	500 ea/cs	

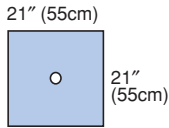

## 9026 Aperture Drape

Overall Size	Drapes/Box	Boxes/Case
21" x 21" (55cm x 55cm)	100	4
• Aperture: 2 1/4" x 3 1/8" (6cm x 8cm)		
• Absorbent Prevention Fabric		
<b>9026NS</b> (non-sterile) <i>Custom Packs Only</i>	700 ea/cs	

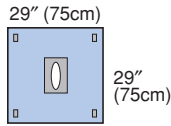

## 9029 Adhesive Aperture Drape

Overall Size	Drapes/Box	Boxes/Case
29" x 29" (75cm x 75cm)	40	4
• Adhesive aperture: 5 7/8" x 2 1/4" (15cm x 6cm)		
• Absorbent Prevention Fabric		
<b>9029NS</b> (non-sterile) <i>Custom Packs Only</i>	300 ea/cs	

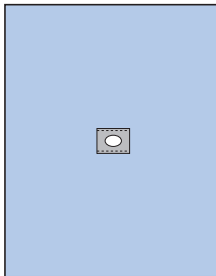

## Adhesive Aperture Drape

	Overall Size	Drapes/Box	Boxes/Case
<i>Centered Aperture</i>			
<b>9030</b>	47" x 59" (120cm x 152cm)	20	4
<i>Off-Centered Aperture</i>			
<b>9031</b>	59" x 72" (150cm x 183cm)	25	2
• Adhesive aperture: 2 1/4" x 3 1/8" (6cm x 8cm)			
• Absorbent Prevention Fabric			
<b>9030NS</b> (non-sterile) <i>Custom Packs Only</i>		115 ea/cs	
<b>9031NS</b> (non-sterile) <i>Custom Packs Only</i>		80 ea/cs	

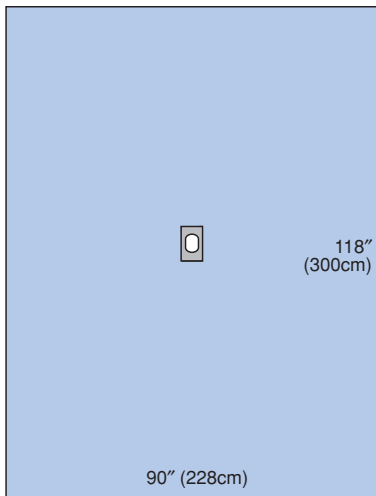

## 9050 Adhesive Aperture Drape

Overall Size	Drapes/Box	Boxes/Case
90" x 118" (228cm x 300cm)	10	2
• Adhesive aperture: 4 5/8" x 6 1/4" (12cm x 16cm)		
• Absorbent Prevention Fabric		
<b>9050NS</b> (non-sterile) <i>Custom Packs Only</i>	30 ea/cs	

### KEY

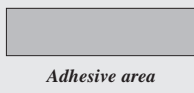
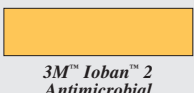
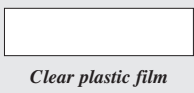
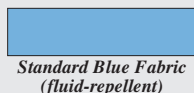
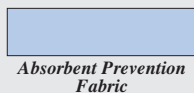

25 yds (22m)

**1000Disp Roll Prep Drape**

Roll Size	Roll/Case	Dispenser/Case
25 yds. x 11" (22m x 30cm)	1	1
<ul style="list-style-type: none"> <li>• Adhesive strip</li> <li>• Non-sterile</li> </ul>		

25 yds (22m)

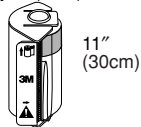
**1000NSR Roll Prep Drape**

Roll Size	Rolls/Case	Dispenser/Case
25 yds. x 11" (22m x 30cm)	8	1
<ul style="list-style-type: none"> <li>• Adhesive strip</li> <li>• Non-sterile</li> </ul>		

17" (45cm)

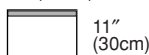
**1000 Small Towel Drape**

Overall Size	Drapes/Box	Boxes/Case
17" x 11" (45cm x 30cm)	10	4
<ul style="list-style-type: none"> <li>• Adhesive strip</li> </ul>		
<b>1000NSD</b> (non-sterile)	100	1
<b>1000NS</b> (non-sterile) <i>Custom Packs Only</i>	200 ea/cs	

17" (45cm)

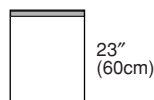
**1010 Large Towel Drape**

Overall Size	Drapes/Box	Boxes/Case
17" x 23" (45cm x 60cm)	10	4
<ul style="list-style-type: none"> <li>• Adhesive strip</li> </ul>		
<b>1010NSD</b> (non-sterile)	100	1
<b>1010NS</b> (non-sterile) <i>Custom Packs Only</i>	200 ea/cs	

29" (75cm)

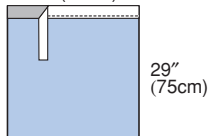
**9084 Adhesive Towel Drape**

Overall Size	Drapes/Box	Boxes/Case
29" x 29" (75cm x 75cm)	40	4
<ul style="list-style-type: none"> <li>• Absorbent Prevention Fabric</li> </ul>		
<b>9084NS</b> (non-sterile) <i>Custom Packs Only</i>	275 ea/cs	

39" (100cm)

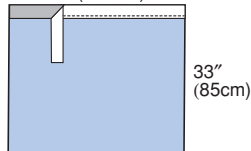
**9085 Adhesive Towel Drape**

Overall Size	Drapes/Box	Boxes/Case
39" x 33" (100cm x 85cm)	30	4
<ul style="list-style-type: none"> <li>• Absorbent Prevention Fabric</li> </ul>		
<b>9085NS</b> (non-sterile) <i>Custom Packs Only</i>	160 ea/cs	

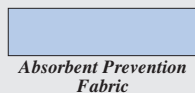
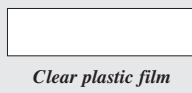
Absorbent Prevention  
FabricStandard Blue Fabric  
(fluid-repellent)

Clear plastic film

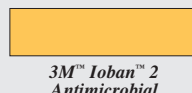
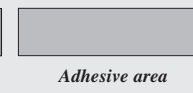
3M™ Ioban™ 2  
Antimicrobial  
Incise Film3M™ Steri-Drape™ 2  
Incise Film

Adhesive area

# SURGICAL SHEETS AND ACCESSORIES

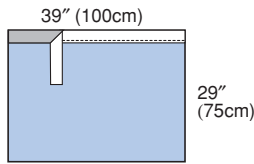

## 9086 Adhesive Towel Drape

Overall Size	Drapes/Box	Boxes/Case
39" x 29" (100cm x 75cm)	40	4
• Absorbent Prevention Fabric		
<b>9086NS</b> (non-sterile) <i>Custom Packs Only</i>	180 ea/cs	

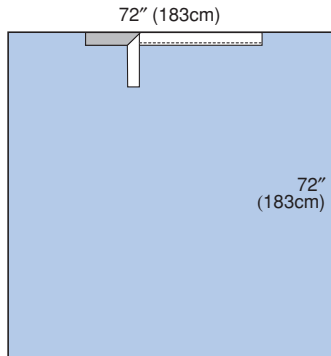

## 9087 Adhesive Drape Sheets

Overall Size	Drapes/Box	Boxes/Case
72" x 72" (183cm x 183cm)	25	2
• Absorbent Prevention Fabric		
<b>9087NS</b> (non-sterile) <i>Custom Packs Only</i>	50 ea/cs	

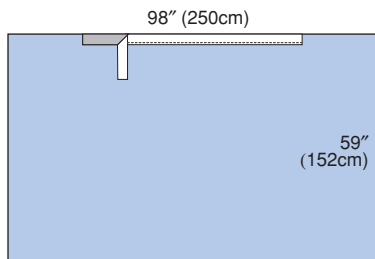

## 9088 Adhesive Drape Sheets

Overall Size	Drapes/Box	Boxes/Case
98" x 59" (250cm x 152cm)	25	2
• Absorbent Prevention Fabric		
<b>9088NS</b> (non-sterile) <i>Custom Packs Only</i>	50 ea/cs	

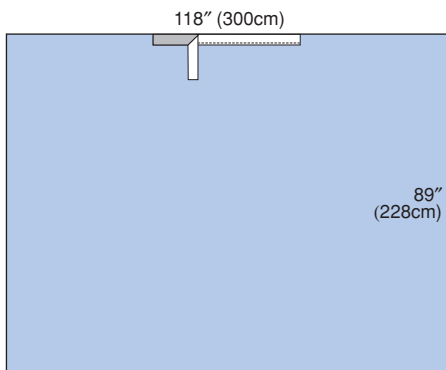

## 9090 Adhesive Drape Sheets

Overall Size	Drapes/Box	Boxes/Case
118" x 89" (300cm x 228cm)	12	2
• Absorbent Prevention Fabric		
<b>9090NS</b> (non-sterile) <i>Custom Packs Only</i>	20 ea/cs	

### KEY

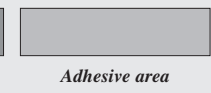
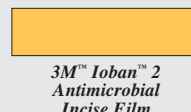
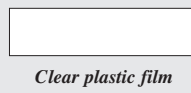
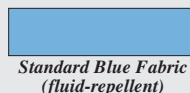
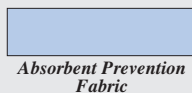



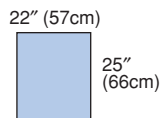

### 1089 Utility Sheet

Overall Size	Drapes/Package	Packages/Box	Box /Case
22" x 25" (57cm x 66cm)	2	80	1

• Absorbent Prevention Fabric

**1089NS** (non-sterile) *Custom Packs Only* 200 ea/cs

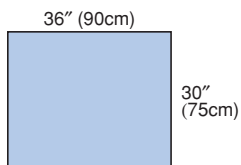

### 9069 Drape Sheet

Overall Size	Drapes/Box	Boxes/Case
36" x 30" (90cm x 75cm)	50	4

• Absorbent Prevention Fabric

**9069NS** (non-sterile) *Custom Packs Only* 300 ea/cs



### 9072 Drape Sheet/Back Table Cover

Overall Size	Drapes/Box	Boxes/Case
44" x 59" (114cm x 150cm)	20	4

• Absorbent Prevention Fabric

**9072NS** (non-sterile) *Custom Packs Only* 90 ea/cs

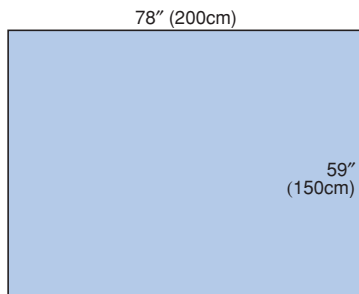

### 9077 Drape Sheet/Back Table Cover

Overall Size	Drapes/Box	Boxes/Case
78" x 59" (200cm x 150cm)	30	2

• Absorbent Prevention Fabric

**9077NS** (non-sterile) *Custom Packs Only* 60 ea/cs

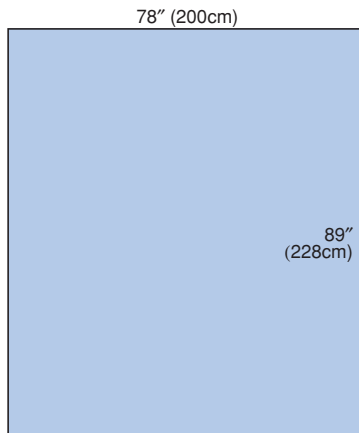

### 9079 Drape Sheet/Back Table Cover

Overall Size	Drapes/Box	Boxes/Case
78" x 89" (200cm x 228cm)	20	2

• Absorbent Prevention Fabric

**9079NS** (non-sterile) *Custom Packs Only* 44 ea/cs

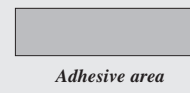
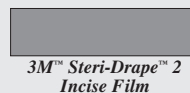
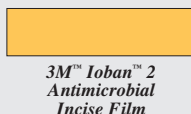
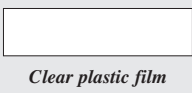
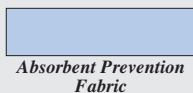

# SURGICAL SHEETS AND ACCESSORIES

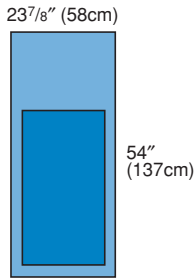

## 9036 Mayo Stand Cover

Overall Size	Drape/Box	Boxes/Case
23 7/8" x 54" (58cm x 137cm)	60	4
• Blue plastic with nonwoven pad		
<b>9036NS</b> (non-sterile) <i>Custom Packs Only</i>	300 ea/cs	

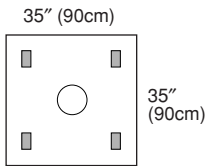

## Wound Edge Protectors

	Overall Size	Ring Diameter	Drapes/Box	Boxes/Case
<b>1073</b>	35" x 35" (90cm x 90cm)	4 3/4" (12cm)	10	4
<b>1074</b>	35" x 35" (90cm x 90cm)	6 5/8" (17cm)	10	4
<b>1075</b>	35" x 35" (90cm x 90cm)	8 5/8" (22cm)	10	4
<b>1076</b>	35" x 35" (90cm x 90cm)	10" (27cm)	10	4
• 4 – Adhesive patches				

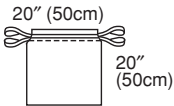

## 1003 Isolation Bag

Overall Size	Drapes/Box	Boxes/Case
20" x 20" (50cm x 50cm)	10	4
• Drawstring closure		
<b>1003NS</b> (non-sterile) <i>Custom Packs Only</i>	200 ea/cs	

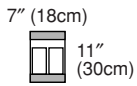

## 1018 Instrument Pouch

Overall Size	Drapes/Box	Boxes/Case
7" x 11" (18cm x 30cm)	10	4
• 2 – Adhesive strips		
• 2 – Compartments		
<b>1018NS</b> (non-sterile) <i>Custom Packs Only</i>	200 ea/cs	

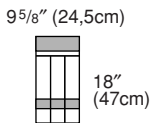

## 1018L Long Instrument Pouch

Overall Size	Drapes/Box	Boxes/Case
9 5/8" x 18" (24,5cm x 47cm)	10	4
• 2 – Adhesive strips		
• 3 – Compartments		
<b>1018LNS</b> (non-sterile) <i>Custom Packs Only</i>	200 ea/cs	

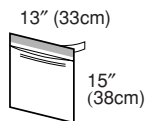

## 9097 Instrument Pouch (L)

Overall Size	Drapes/Box	Boxes/Case
13" x 15" (33cm x 38cm)	100	2
<b>9097NS</b> (non-sterile) <i>Custom Packs Only</i>	336 ea/cs	

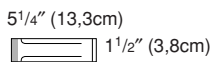

### 1115 Tube Organiser

Overall Size	Drapes/Box	Boxes/Case
5 1/4" x 1 1/2" (13,3cm x 3,8cm)	100	4

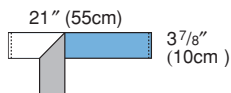

### 9099 OP Tape

Overall Size	Drapes/Box	Boxes/Case
3 7/8" x 21" (10cm x 55cm)	250	2
<b>9099NS</b> (non-sterile) <i>Custom Packs Only</i>	1050 ea/cs	

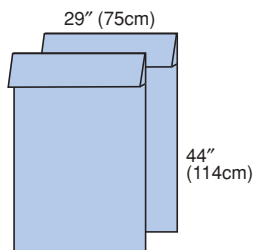

### 9040 Leggings (pair)

Overall Size	Drapes/Box	Boxes/Case
29" x 44" (75cm x 114cm)	12	4
• Absorbent Prevention Fabric		
<b>9040NS</b> (non-sterile) <i>Custom Packs Only</i>	116 ea/cs	

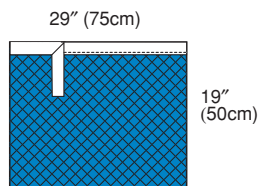

### 9095 Absorbent Pad

Overall Size	Drapes/Box	Boxes/Case
29" x 19" (75cm x 50cm)	50	4

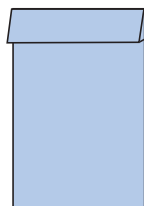

### Extremity Cover

	Overall Size	Drapes/Box	Boxes/Case
<b>9041</b>	13 1/2" x 23 1/2" (35cm x 60cm)	50	4
<b>9042</b>	13 1/2" x 39" (35cm x 100cm)	35	4
• Absorbent Prevention Fabric			
<b>9041NS</b> (non-sterile)		380 ea/cs	
<b>9042NS</b> (non-sterile) <i>Custom Packs Only</i>		250 ea/cs	

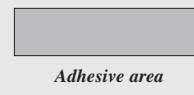
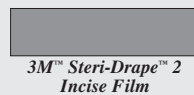
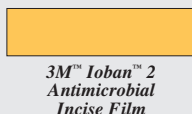
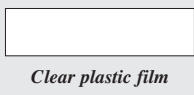

# 3M™ Steri-Drape™ FLUID COLLECTION POUCHES

9 1/4" (23,6cm)

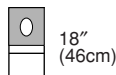

## 1072 Aperture Pouch Drape

Overall Size	Packs/Box	Boxes/Case
9 1/4" x 18" (23,6cm x 46cm)	10	4
<ul style="list-style-type: none"> <li>• Adhesive area: 9 1/4" x 10" (23,6cm x 26cm)</li> <li>• Oval aperture: 3 1/2" x 4 1/4" (9,2cm x 11,6cm)</li> <li>• Fluid collection pouch</li> </ul>		
<b>1072NS</b> (non-sterile) <i>Custom Packs Only</i>	200 ea/cs	

19" (50cm)

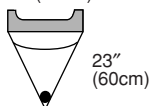

## 1016 Irrigation Pouch

Overall Size	Drapes/Box	Boxes/Case
19" x 23" (50cm x 60cm)	10	4
<ul style="list-style-type: none"> <li>• Adhesive strip</li> <li>• 1 – Exit port</li> <li>• Screen</li> </ul>		
<b>1016NS</b> (non-sterile) <i>Custom Packs Only</i>	200 ea/cs	

17" (45cm)

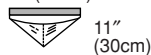

## 1027 Irrigation Pouch

Overall Size	Drapes/Box	Boxes/Case
17" x 11" (45cm x 30cm)	10	4
<ul style="list-style-type: none"> <li>• Adhesive strip</li> </ul>		

34" (86cm)

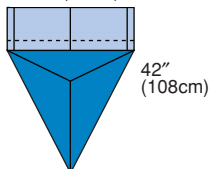

## 1084 Under Buttocks Drape with Pouch

Overall Size	Drapes/Box	Box/Case
34" x 42" (86cm x 108cm)	30	4
<ul style="list-style-type: none"> <li>• Cuff size: 10" (27cm)</li> <li>• Fluid collection pouch</li> <li>• Absorbent Prevention Fabric</li> </ul>		
<b>1084NS</b> (non-sterile) <i>Custom Packs Only</i>	140 ea/cs	

15" (40cm)

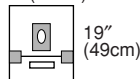

## 1024 Small Drape with Adhesive Aperture and Pouch

Overall Size	Drapes/Box	Boxes/Case
15" x 19" (40cm x 49cm)	10	4
<ul style="list-style-type: none"> <li>• Adhesive area: 3 7/8" x 4 7/8" (10cm x 12,5cm)</li> <li>• Oval aperture: 1 3/8" x 2 3/8" (3,5cm x 6,3cm)</li> <li>• 2 – Adhesive patches</li> <li>• Fluid collection pouch</li> </ul>		
<b>1024NS</b> (non-sterile)	200	

### KEY

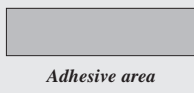
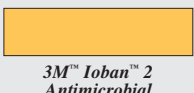
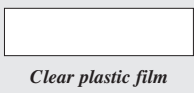
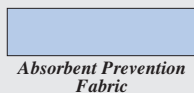

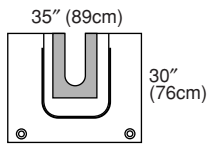

### 1067 U-pouch

Overall Size	Drapes/Box	Boxes/Case
35" x 30" (89cm x 76cm)	5	4
<ul style="list-style-type: none"> <li>• Adhesive split: 6" x 15" (16cm x 40cm)</li> <li>• Fluid collection pouch</li> <li>• 2 – Exit ports</li> </ul>		
<b>1067NS</b> (non-sterile) <i>Custom Packs Only</i>	50 ea/cs	

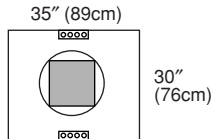

### 2057 Incise Pouch

Overall Size	Drapes/Box	Boxes/Case
35" x 30" (89cm x 76cm)	10	4
<ul style="list-style-type: none"> <li>• Aperture incise area: 12" x 12" (30cm x 30cm)</li> <li>• 360-degree fluid collection pouch</li> <li>• Tube and cord organizers</li> </ul>		
<b>2057NS</b> (non-sterile) <i>Custom Packs Only</i>	100 ea/cs	

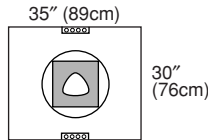

### 2058 Aperture Pouch

Overall Size	Drapes/Box	Boxes/Case
35" x 30" (89cm x 76cm)	10	4
<ul style="list-style-type: none"> <li>• Aperture incise area: 12" x 12" (30cm x 30cm)</li> <li>• 360-degree fluid collection pouch</li> <li>• Tube and cord organizers</li> </ul>		
<b>2058NS</b> (non-sterile) <i>Custom Packs Only</i>	100 ea/cs	

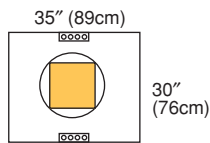

### 6657 Pouch with Ioban 2 Incise Film

Overall Size	Drapes/Box	Boxes/Case
35" x 30" (89cm x 76cm)	10	4
<ul style="list-style-type: none"> <li>• Ioban 2 antimicrobial incise area: 12" x 12" (30cm x 30cm)</li> <li>• 360-degree fluid collection pouch</li> <li>• Tube and cord organizers</li> </ul>		

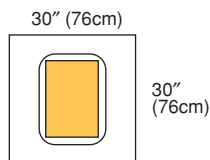

### 6658 Pouch with Ioban 2 Incise Film, Large

Overall Size	Drapes/Box	Boxes/Case
30" x 30" (76cm x 76cm)	5	4
<ul style="list-style-type: none"> <li>• Ioban 2 antimicrobial incise area: 13" x 17" (33cm x 43cm)</li> <li>• 360-degree fluid collection pouch</li> </ul>		

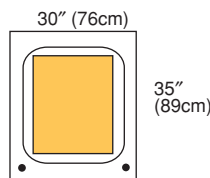

### 6659 Pouch with Ioban 2 Incise Film, Extra Large

Overall Size	Drapes/Box	Boxes/Case
30" x 35" (76cm x 89cm)	5	4
<ul style="list-style-type: none"> <li>• Ioban 2 antimicrobial incise area: 16" x 20" (42cm x 52cm)</li> <li>• 360-degree fluid collection pouch</li> <li>• 2 – exit ports</li> </ul>		

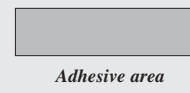
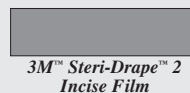
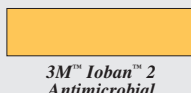
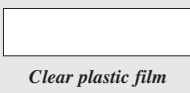
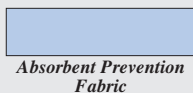

# 3M™ Steri-Drape™ EQUIPMENT DRAPES

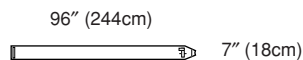

## 1100 Camera/Laser Drape

Overall Size	Drapes/Box	Box/Case
7" x 96" (18cm x 244cm)	25	1
<ul style="list-style-type: none"> <li>• Telescopically folded</li> <li>• Expandable aperture</li> </ul>		

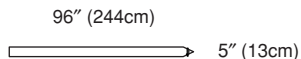

## 4730 Video Camera/Laser Drape

Overall Size	Drapes/Box	Box/Case
5" x 96" (13cm x 244cm)	25	1
<ul style="list-style-type: none"> <li>• Telescopically folded</li> <li>• Perforated, tear-off tip</li> </ul>		

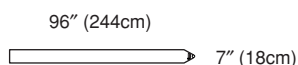

## 4731 Closed System Video Camera Drape

Overall Size	Drapes/Box	Box/Case
7" x 96" (18cm x 244cm)	25	1
<ul style="list-style-type: none"> <li>• Telescopically folded</li> <li>• Clear lens</li> </ul>		

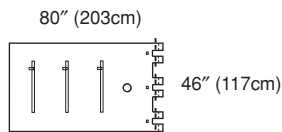

## 4785 Microscope Drape for Zeiss® MD®

Overall Size	Drapes/Box	Boxes/Case
46" x 80" (117cm x 203cm)	5	2
<ul style="list-style-type: none"> <li>• Observer tubes</li> </ul>		

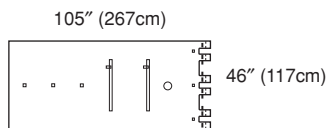

## 4786 Microscope Drape for Zeiss® MD®

Overall Size	Drapes/Box	Boxes/Case
46" x 105" (117cm x 267cm)	5	2
<ul style="list-style-type: none"> <li>• Observer tubes</li> <li>• Long body</li> </ul>		

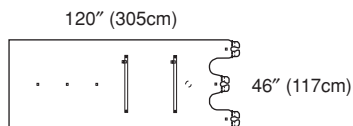

## 4787 Microscope Drape for Zeiss® MD®

Overall Size	Drapes/Box	Boxes/Case
46" x 120" (117cm x 305cm)	5	2
<ul style="list-style-type: none"> <li>• Observer tubes</li> <li>• Extra-long body</li> </ul>		

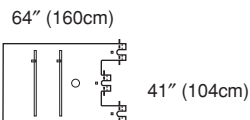

## 4788 Microscope Drape for Zeiss® OPMI®

Overall Size	Drapes/Box	Boxes/Case
41" x 64" (104cm x 160cm)	10	2
<ul style="list-style-type: none"> <li>• Observer tubes</li> </ul>		

### KEY

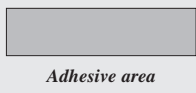
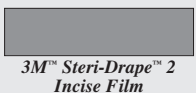
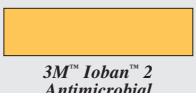
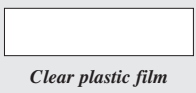
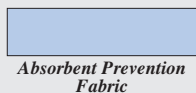

105" (267cm)

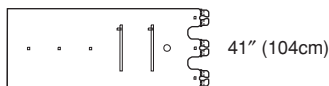

### 4789 Microscope Drape for Zeiss® OPMI®

Overall Size	Drapes/Box	Boxes/Case
41" x 105" (104cm x 267cm)	5	2

- Observer tubes
- Long body

120" (305cm)

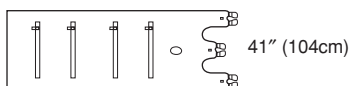

### 4790 Microscope Drape for Zeiss® OPMI®

Overall Size	Drapes/Box	Boxes/Case
41" x 120" (104cm x 305cm)	5	2

- Observer tubes
- Extra-long body

105" (267cm)

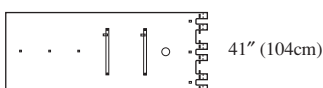

### 4791 Microscope Drape for Leica®

Overall Size	Drapes/Box	Boxes/Case
41" x 105" (104cm x 267cm)	5	2

- Observer tubes
- Long body

120" (305cm)

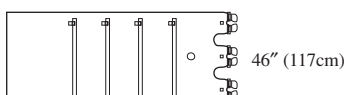

### 4792 Microscope Drape for Leica® M680

Overall Size	Drapes/Box	Boxes/Case
46" x 120" (117cm x 305cm)	5	2

- Observer tubes
- Extra-long body
- Special angled lens for reduced glare

150" (381cm)

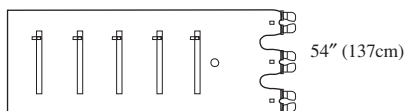

### 4793 Microscope Drape for Leica® Space Pointer

Overall Size	Drapes/Box	Boxes/Case
54" x 150" (137cm x 381cm)	5	2

- Observer tubes
- Extra-long body

105" (267cm)

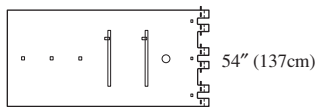

### 4794 Microscope Drape for Leica®

Overall Size	Drapes/Box	Boxes/Case
54" x 105" (137cm x 267cm)	5	2

- Observer tubes
- Long body

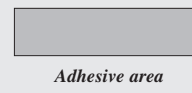
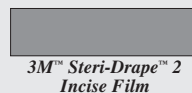
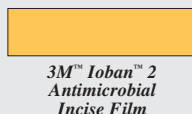
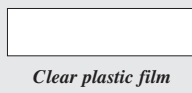
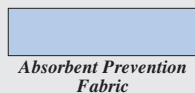

# 3M™ Steri-Drape™ EQUIPMENT DRAPES

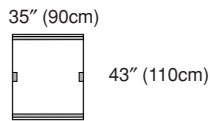

## 1012 Fluroscope Drape

Overall Size	Drapes/Box	Boxes/Case
35" x 43" (90cm x 110cm)	10	4
• Adhesive strips for gathering excess materials		
<b>1012NS</b> (non-sterile)	200	

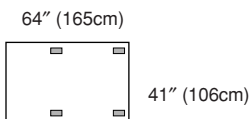

## 1013 C-arm Drape

Overall Size	Drapes/Box	Boxes/Case
41" x 64" (106cm x 165cm)	10	4
• Adhesive strips for gathering excess materials		
<b>1013NS</b> (non-sterile)	100	

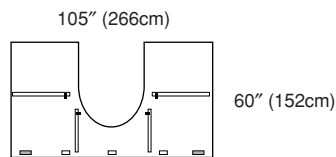

## 1101 One Piece C-arm Drape

Overall Size	Drapes/Box	Boxes/Case
60" x 105" (152cm x 266cm)	10	2
• Poly straps for gathering excess material		
• Covers the C-arm completely		

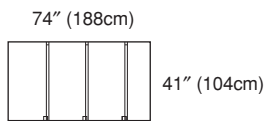

## 4738 C-arm Drape

Overall Size	Drapes/Box	Boxes/Case
41" x 74" (104cm x 188cm)	10	2
• Telescopically folded		
• Poly straps for gathering excess material		
• Long body		

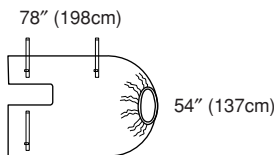

## 4739 Mini C-arm Drape

Overall Size	Drapes/Case
54" x 78" (137cm x 198cm)	40
• Latex-free band	
• Elastic opening	

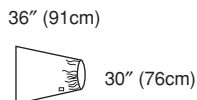

## 4750 Banded Fluroscope Drape

Overall Size	Drapes/Case	Box/Case
36" x 30" (91cm x 76cm)	25	1
• Latex-free band		
• Adhesive strips for gathering excess materials		



14" (36cm)



19" (49cm)

### 1008 X-ray Cassette Drape

Overall Size	Drapes/Box	Boxes/Case
14" x 19" (36cm x 49cm)	25	1
<ul style="list-style-type: none"> <li>• Adhesive closure</li> <li>• Easy-open collar</li> <li>• Smaller size</li> </ul>		

20" (52cm)



23" (60cm)

### 1009 X-ray Cassette Drape

Overall Size	Drapes/Box	Box/Case
20" x 23" (52cm x 60cm)	25	1
<ul style="list-style-type: none"> <li>• Adhesive closure</li> <li>• Easy-open collar</li> </ul>		

23" (60cm)



25" (63cm)

### 1011 Large X-ray Cassette Drape

Overall Size	Drapes/Box	Boxes/Case
23" x 25" (60cm x 63cm)	25	2
<ul style="list-style-type: none"> <li>• Adhesive closure</li> </ul>		

40" (102cm)



24" (61cm)

### 4741 X-ray Cassette Drape

Overall Size	Drapes/Box	Box/Case
24" x 40" (61cm x 102cm)	50	1
<ul style="list-style-type: none"> <li>• Fold-and-lock closure design with extra-large cuff</li> </ul>		

24" (61cm)



20" (51cm)

### 4742 X-ray Cassette Drape with Liner

Overall Size	Drapes/Box	Boxes/Case
20" x 24" (51cm x 61cm)	25	2
<ul style="list-style-type: none"> <li>• Release liner</li> </ul>		

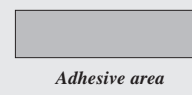
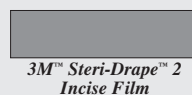
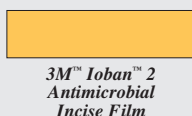
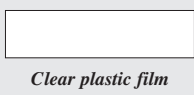
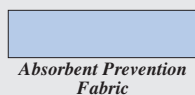

# 3M™ Steri-Drape™ EQUIPMENT DRAPES

17" (45cm)



## 1096 Banded Bag

Overall Size	Drapes/Box	Box/Case
17" (45cm)	25	1

- Latex-free band

23" (60cm)



## 1097 Banded Bag

Overall Size	Drapes/Box	Box/Case
23" (60cm)	25	1

- Latex-free band

35" (91cm)



## 1098 Banded Bag

Overall Size	Drapes/Box	Box/Case
35" (91cm)	25	1

- Latex-free band

45" (116cm)



## 1099 Banded Bag

Overall Size	Drapes/Box	Box/Case
45" (116cm)	25	1

- Latex-free band

44" (112cm)



66" (168cm)

## 4783 Slush Machine Drape

Overall Size	Drapes/Case	Box/Case
44" x 66" (112cm x 168cm)	24	1

- Strong polyurethane material

66" (168cm)



66" (168cm)

## 4784 Slush Machine Drape

Overall Size	Drapes/Case	Box/Case
66" x 66" (168cm x 168cm)	24	1

- Strong polyurethane material

### KEY

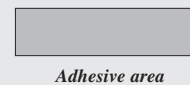
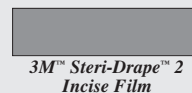
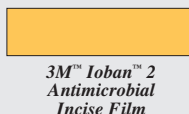
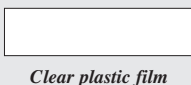
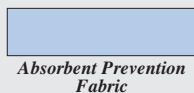



**For more information**

For more information about 3M surgical drapes or other 3M Health Care products:

- Contact your local 3M representative
- Call the 3M Health Care Customer Helpline: **1-800-228-3957**
- Visit the 3M Health Care products Web site: **[www.3M.com/infection prevention](http://www.3M.com/infection_prevention)**

**3M Infection Prevention Solutions. A vital step in infection prevention.**

**Health Care**

3M Center, Building 275-4W-02  
St. Paul, MN 55144-1000  
USA  
1-800-228-3957  
[www.3M.com/healthcare](http://www.3M.com/healthcare)

**3M Canada**

Post Office Box 5757  
London, Ontario N6A 4T1  
Canada  
1-800-563-2921



*Minimum 10% Post-Consumer Fiber*

Printed in U.S.A.  
Revised 12/05  
© 3M 2002, 2003, 2005  
All Rights Reserved  
70-2009-1582-8 (57.25) DPI