

Twist-Lock® Devices
 15A, 125V, 2 Pole, 3 Wire Grounding
 Insulgrip® Flanged Receptacle

HUBBELL

Features

- Impact resistant thermoplastic construction
- Backwired terminations for ease of installation
- #8-32 Multiple drive terminal screws (Slotted, Phillips, Robertson)
- Mounting screws included



Ordering Information

Description	Device Color	UPC	Catalog Number
Nylon casing, back wired.	White	783585171005	HBL4715C

Listings

Listed to UL 498
 Fed. Spec. W-C-596
 Certified to CSA C22.2 No.42

Specifications

Housing	Nylon
Terminal Retainer	Clear polycarbonate
Contacts	Brass
Terminal Clamp	#8-32 Brass (Phillips / Slotted / Robertson)
Terminal Clamp	Cold rolled steel – nickel plated
Assembly Screws	Steel - zinc plated
Mounting Screw	Nickel plated brass

Performance

Electrical	
Current Interrupting	Certified for current interrupting at full rated current
Dielectric Voltage	Withstands 2,000V minimum
Mechanical	
Terminal Accommodation	#18 AWG - #10 AWG solid or stranded copper wire only.
Terminal Identification	Terminals identified in accordance with UL 498
Environmental	
Flammability	HB or better per UL94/CSA 22.2 No.0.17
Moisture Resistance	IP20 Suitability
Operating Temperatures	Maximum Continuous 75°C; Minimum -40°C (w/o impact)

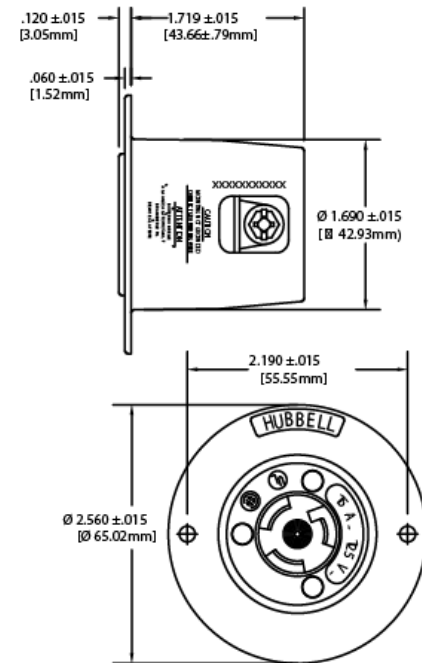

Accessories

Plug	HBL4720C
Weatherproof Lift Cover	WP1

Resources

Customer Use Drawing
 eCatalog

Dimensions in Inches (mm)

Hubbell Wiring Device-Kellems • Hubbell Incorporated (Delaware) • 40 Waterview Drive • Shelton, CT 06484

Phone (800) 288-6000 • Fax (800) 255-1031 • Specifications subject to change without notice.

